



**NOWE  
MODELE**

## konstrukcja

Promieniowy wentylator kanałowy z silnikiem oddzielnym od strumienia przepływającego powietrza. Obudowa w najwyższej klasie szczelności L1 (wg. EN 1886), wykonana z galwanizowanej blachy stalowej ma kształt sześcianu składającego się z ramy i paneli bocznych, izolowanych (poza panelem wlotowym) warstwą wełny mineralnej o grubości 30mm. W wykonaniu standardowym wlot stanowi wyprofilowany pierścień bez króćca przyłączeniowego. Wylot uzyskuje się przez zdjęcie jednego z izolowanych paneli bocznych. Wylot można skonfigurować względem wlotu tylko pod kątem 90°. Po stronie wylotu zastosować można panele USB wyposażone w okrągłe króćce przyłączeniowe lub panele USB z redukcją do przyłącza okrągłego. Po stronie wlotu istnieje możliwość montażu okrągłych króćców wlotowych ASB. W celu ograniczenia dodatkowych oporów, które powstaną przy stosowaniu powyższych paneli i króćców należy zwrócić szczególną uwagę na zachowanie odcinków prostych kanałów oraz króćców o jak największej średnicy przyłączeniowej. W podstawie wentylatora zlokalizowany został króciec skroplin (gwint wewnętrzny). Instalacja powinna być wyposażona w stosowne filtry / łapacze tłuszczu.

## wirnik

Wirnik nowej generacji wyważony dynamicznie w klasie G2.5, typu B - z łopatkami pochylonymi do tyłu, wykonany z blachy stalowej malowanej proszkowo.

## napęd i sterowanie

Jednofazowy (230V, 50Hz, IP54, klasa izolacji F) lub trójfazowy (400V, 50Hz, IP55, klasa izolacji F) asynchroniczny silnik elektryczny zlokalizowany całkowicie poza strumieniem usuwanego powietrza.

Prędkość obrotowa modeli jednofazowych może być kontrolowana przy pomocy regulatorów transformatorowych. Zalecany zakres regulacji napięcia 110-230V. Silniki te posiadają czujniki temperatury uzwojeń typu termokontakt, które muszą być podłączone i monitorowane przez zewnętrzne urządzenie ochrony termicznej, np. automatykę, przekaźnik wbudowany w regulator, przekaźnik SET10 itp.

Prędkość obrotowa modeli z silnikami trójfazowymi (3x230Δ/3x400Y) może być kontrolowana za pomocą przemienników częstotliwości, wyłącznic w zakresie częstotliwości (obrotów) podanych w tabeli/wykresie doboru. Zalecany czas przyspieszania i hamowania przetwornicą (rampa): 20-30 sek.

W przypadku bezpośredniego podłączenia silników trójfazowych do sieci należy je zabezpieczyć przy pomocy wyłączników silnikowych z wbudowanym wyłączaczem zwarciovym i przeciążeniowym.

Nastawa wyzwalacza termicznego wyłącznika silnikowego musi być dostosowana do rzeczywistych parametrów pracy wentylatora i nie wyższa niż wartość I<sub>max</sub> dla wentylatora.

## maksymalna temperatura pracy

60 ÷ 80°C - temperatura medium dla modeli z silnikami jednofazowymi

120°C - temperatura medium dla modeli z silnikami trójfazowymi.

## zastosowanie

Efektywny odciąg oparów z kuchni przemysłowych w obiektach gastronomicznych. Możliwość zastosowania we wszelkich instalacjach odciągowych wymagających odprowadzania powietrza o podwyższonej temperaturze.

## Akcesoria



**GS**  
wyłącznik serwisowy  
str. nr 548



**STRS-1**  
regulator transformatorowy  
str. nr 533



**iG5A**  
przebiegnik częstotliwości  
str. nr 550



**WPH**  
osłona wlotu / wylotu  
str. nr 289



**USB**  
panel boczny na wylot  
str. nr 288



**RCP**  
osłona dachowa  
str. nr 289



**WPS**  
żaluzja na wylot  
str. nr



**ASB**  
króciec wlotowy  
str. nr



**USR**  
panel boczny na wylot z redukcją  
str. nr

tablica doboru akcesoriów dla danego wentylatora MBC.K

Typ MBC.K	225/1700S	250/2600S	280/3300S	315/3800S	400/4500S	450/6000S	500/7800S
Wyłącznik serwisowy	GS 01	GS 01	GS 01	GS 01	GS 01	GS 01	GS 01
S-bieg, reg. wbudowane zabezp. termiczne	STRS-1-35L22	STRS-1-50L22	STRS-1-50L22	STRS-1-100L22	STRS-1-35L22	STRS-1-50L22	STRS-1-100L22
Zabezpieczenie termiczne	S-ET 10	S-ET 10	S-ET 10	S-ET 10	S-ET 10	S-ET 10	-
Osłona silnika	MBS 01	MBS 01	MBS 01	MBS 01	MBS 02	MBS 02	MBS 02
Panel boczny na wylot	USB 01/02	USB 02	USB 02	USB 02	USB 03/04/05	USB 04/05	USB 04/05
Panel boczny na wylot z redukcją	USR 01/02	USR 01/02	USR 01/02	USR 01/02	USR 04/05/06	USR 04/05/06	USR 04/05/06
Osłona wlotu/wylotu	WPH 01	WPH 01	WPH 01	WPH 01	WPH 02	WPH 02	WPH 02
Osłona dachowa	RCP 01	RCP 01	RCP 01	RCP 01	RCP 02	RCP 02	RCP 02
Rama montażowa	BAF 01	BAF 01	BAF 01	BAF 01	BAF 02	BAF 02	BAF 02
Króciec wlotowy	ASB 01/02/03	ASB 03	ASB 03	ASB 03	ASB 04/05/06	ASB 05/06	ASB 05/06
Żaluzja na wylot	WPS 01	WPS 01	WPS 01	WPS 02	WPS 02	WPS 02	WPS 02

Typ MBC.K	225/2000T	250/2600T	280/2800T	315/4100T	315/3300T	355/4600T	400/4800T
Wyłącznik serwisowy	GS 03	GS 03	GS 03	GS 03	GS 03	GS 03	GS 03
Wyłącznik silnikowy	1,0 - 1,6 A	1,0 - 1,6 A	1,0 - 1,6 A	2,5 - 4,0 A	1,0 - 1,6 A	1,0 - 1,6 A	1,0 - 1,6 A
Przebiegnik częstotliwości 1x230V/3x230V	SV008iC5-1F	SV008iC5-1F	SV008iC5-1F	SV015iC5-1F	SV008iC5-1F	SV008iC5-1F	SV008iC5-1F
Przebiegnik częstotliwości 3x400V/3x400V	SV008iG5A-4	SV008iG5A-4	SV008iG5A-4	SV015iG5A-4	SV008iG5A-4	SV008iG5A-4	SV008iG5A-4
Osłona silnika	MBS 01	MBS 01	MBS 01	MBS 01	MBS 01	MBS 02	MBS 02
Panel boczny na wylot	USB 01/02	USB 02	USB 02	USB 02	USB 02	USB 03/04/05	USB 03/04/05
Panel boczny na wylot z redukcją	USR 01/02/03	USR 02/03	USR 02/03	USR 02/03	USR 02/03	USR 04/05/06	USR 04/05/06
Osłona wlotu/wylotu	WPH 01	WPH 01	WPH 01	WPH 01	WPH 01	WPH 02	WPH 02
Osłona dachowa	RCP 01	RCP 01	RCP 01	RCP 01	RCP 01	RCP 02	RCP 02
Rama montażowa	BAF 01	BAF 01	BAF 01	BAF 01	BAF 01	BAF 02	BAF 02
Króciec wlotowy	ASB 01/02/03	ASB 03	ASB 03	ASB 03	ASB 03	ASB 04/05/06	ASB 04/05/06
Żaluzja na wylot	WPS 01	WPS 01	WPS 01	WPS 01	WPS 01	WPS 02	WPS 02

tablica doboru akcesoriów dla danego wentylatora MBC.K

Typ MBC.K	450/7100T	500/8100T	560/13100T	630/17500T
Wyłącznik serwisowy	GS 03	GS 03	GS 03	GS 03
Wyłącznik silnikowy	2,5 - 4,0 A	2,5 - 4,0 A	4,0 - 6,3 A	6,3 - 10 A
Przebiegnik częstotliwości 1x230V/3x230V	SV015iC5-1F	SV015iC5-1F	SV022iC5-1F	-
Przebiegnik częstotliwości 3x400V/3x400V	SV015iG5A-4	SV015iG5A-4	SV022iG5A-4	SV040iG5A-4
Ośłona silnika	MBS 02	MBS 02	MBS 03	MBS 03
Panel boczny na wylot	USB 04/05	USB 04/05	USB 07/08	USB 07/08
Panel boczny na wylot z redukcją	USR 04/05/06	USR 04/05/06	USR 07/08	USR 07/08
Ośłona wlotu/wylotu	WPH 02	WPH 02	WPH 03	WPH 03
Ośłona dachowa	RCP 02	RCP 02	RCP 03	RCP 03
Rama montażowa	BAF 02	BAF 02	BAF 03	BAF 03
Króciec wlotowy	ASB 05/06	ASB 05/06	ASB 07/08	ASB 07/08
Żaluzja na wylot	WPS 02	WPS 02	WPS 03	WPS 03

dane techniczne

Typ	V <sub>max</sub> [m <sup>3</sup> /h]	Δp <sub>max</sub> [Pa]	P <sub>max</sub> [W]	U [V]	I <sub>max</sub> [A]	RPM <sub>max</sub> [1/min]	t <sub>max</sub> [°C]	L <sub>WA</sub> [dB(A)]	L <sub>PA</sub> [dB(A)]	m [kg]	nr katalogowy
MBC.K 225/1700S	1740	660	285	230	2,1	2920	80	67	60	36	13788500
MBC.K 250/2600S	2610	790	454	230	3,4	2950	80	73	66	44	12667900
MBC.K 280/3300S	3340	980	703	230	4,1	2910	80	75	68	46	12668100
MBC.K 315/3800S	4225	1270	1319	230	7,6	2930	80	74	67	45	13682900
MBC.K 400/4500S	4590	510	499	230	2,8	1450	80	63	56	59	13688700
MBC.K 450/6000S	5960	640	793	230	4,5	1450	65 (80)*	70	63	73	12662400
MBC.K 500/7800S	7800	815	1429	230	7,9	1460	80	71	64	81	14118600

\* w nawiasie podana maksymalna temperatura przetłaczanego medium podczas pracy bez regulacji prędkości obrotowej

Typ	V <sub>max</sub> [m <sup>3</sup> /h]	Δp <sub>max</sub> [Pa]	P <sub>max</sub> [W]	P <sub>nom</sub> [W]	U [V]	I <sub>max</sub> [A]	F <sub>nom</sub> [Hz]	f <sub>min</sub> - f <sub>max</sub> [Hz]	RPM <sub>max</sub> [1/min]	RPM <sub>nom</sub> [1/min]	t <sub>max</sub> <sup>*</sup> [°C]	L <sub>WA</sub> [dB(A)]	L <sub>PA</sub> [dB(A)]	m [kg]	nr katalogowy
MBC.K 225/2000T	2010	940	440	291	3~230/400(Δ/Y)	0,85	50	20-60	3520	2920	60	73	66	35	14068400
MBC.K 250/2600T	2630	1130	692	438	3~230/400(Δ/Y)	1,2	50	20-60	3490	2870	60	73	66	35	14068200
MBC.K 280/2800T	2830	980	686	686	3~230/400(Δ/Y)	1,26	50	20-50	2920	2790	60	73	66	36	14068000
MBC.K 315/4100T	4115	1270	1208	1208	3~230/400(Δ/Y)	2,45	50	20-50	2950	2860	60	75	68	41	14067800
MBC.K 315/3300T	3300	810	658	221	3~230/400(Δ/Y)	1,13	50	20-80	2360	1480	60	68	61	40	14067600
MBC.K 355/4600T	4590	810	793	338	3~230/400(Δ/Y)	1,37	50	20-70	2060	1470	60	76	69	40	14068800
MBC.K 400/4800T	4840	505	564	564	3~230/400(Δ/Y)	1,1	50	20-50	1470	1440	60	69	62	65	14069000
MBC.K 450/7100T	7125	810	1226	967	3~230/400(Δ/Y)	2,5	50	20-55	1630	1470	60	73	66	73	14069200
MBC.K 500/8100T	8090	840	1440	1440	3~230/400(Δ/Y)	2,85	50	20-50	1485	1450	60	77	70	75	14069400
MBC.K 560/13100T	13060	1040	2661	2661	3~230/400(Δ/Y)	5	50	20-50	1470	1430	60	76	69	127	14117400
MBC.K 630/17500T	17540	1330	4325	4325	3~230/400(Δ/Y)	8,8	50	20-50	1480	1452	60	79	72	140	14138000

\* Max temperatura otoczenia. Temperatura medium dla modeli trójfazowych wynosi 120°C

wymiary

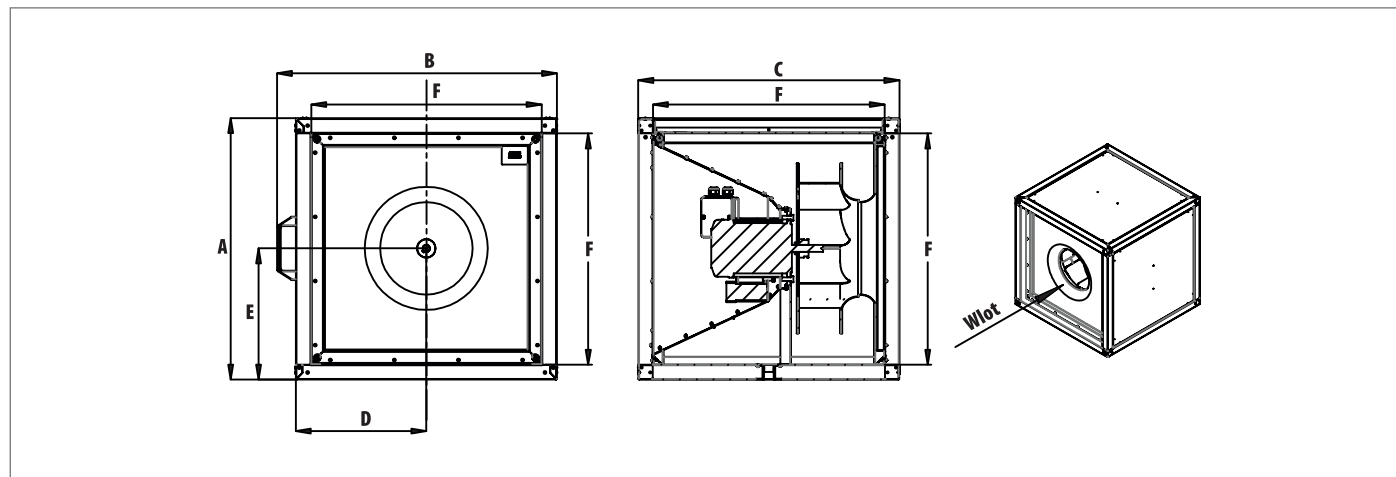

wymiary

Typ	A [mm]	B [mm]	C [mm]	D [mm]	E [mm]	F x F [mm]
MBC.K 225	500	552	500	250	250	417x417
MBC.K 250	500	552	500	250	250	417x417
MBC.K 280	500	552	500	250	250	417x417
MBC.K 315	500	552	500	250	250	417x417
MBC.K 355	700	752	700	350	350	617x617
MBC.K 400	700	752	700	350	350	617x617
MBC.K 450	700	752	700 <td 350	350	617x617	
MBC.K 500	700	752	700	350	350	617x617
MBC.K 560	900	952	900	450	450	817x817
MBC.K 630	900	952	900	450	450	817x817

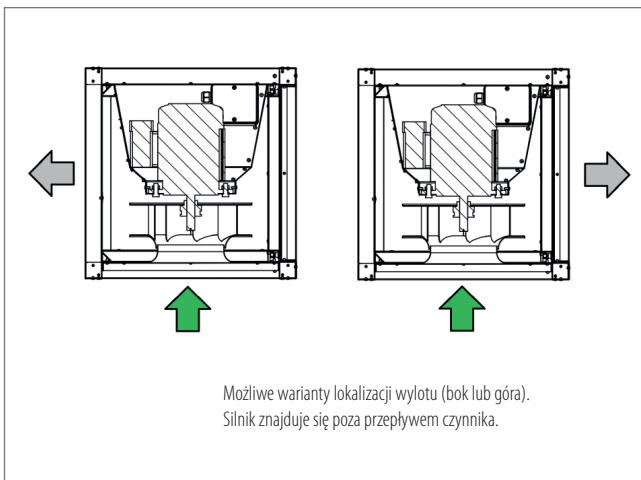

Schematy podłączenia elektrycznego

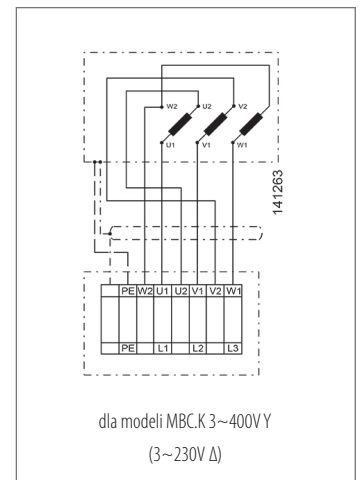
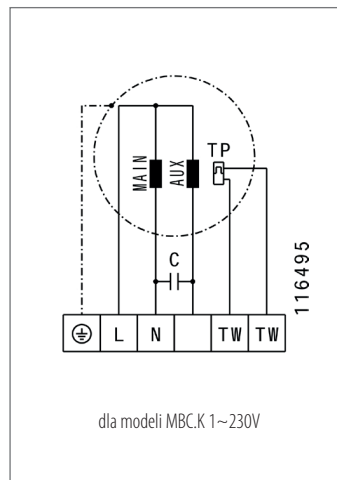

charakterystyki pracy

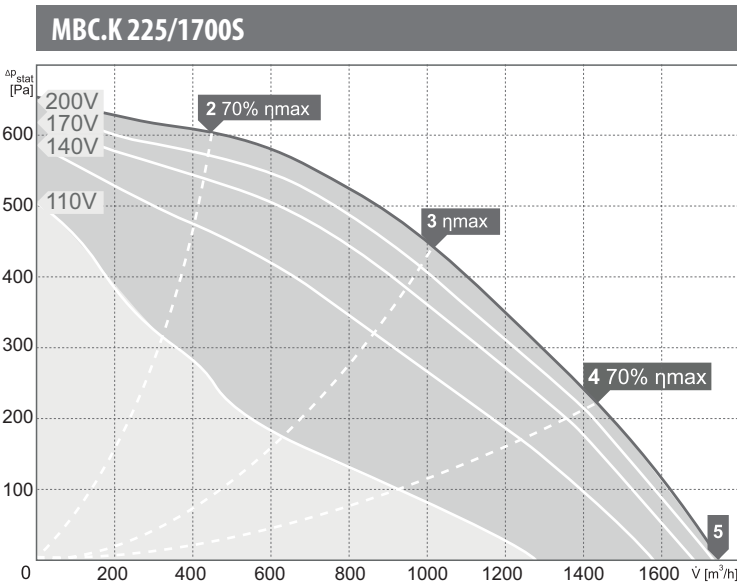

wartości mocy akustycznej  $L_{WA}$  [dB(A)]  
dla poszczególnych częstotliwości pasm oktaowych [Hz]

Pkt. Pracy	tot	Częstotliwości pasm oktaowych [Hz]							
		63	125	250	500	1000	2000	4000	8000
$L_{WA}$ wlot [dB(A)]									
2	73	53	59	65	65	67	65	62	58
3	71	52	53	60	64	65	64	61	57
4	75	56	52	69	68	68	67	65	58
5	78	59	55	73	71	70	69	69	60
$L_{WA}$ wylot [dB(A)]									
2	76	62	68	68	67	69	70	64	57
3	75	56	65	65	66	69	69	62	56
4	78	48	62	67	68	72	74	70	59
5	80	51	60	69	70	74	76	72	64
$L_{WA}$ od obudowy [dB(A)]									
2	68	56	59	56	57	61	61	60	57
3	67	55	53	58	58	60	61	58	57
4	69	62	53	62	61	61	62	58	52
5	71	65	53	64	63	62	63	59	53

charakterystyki pracy

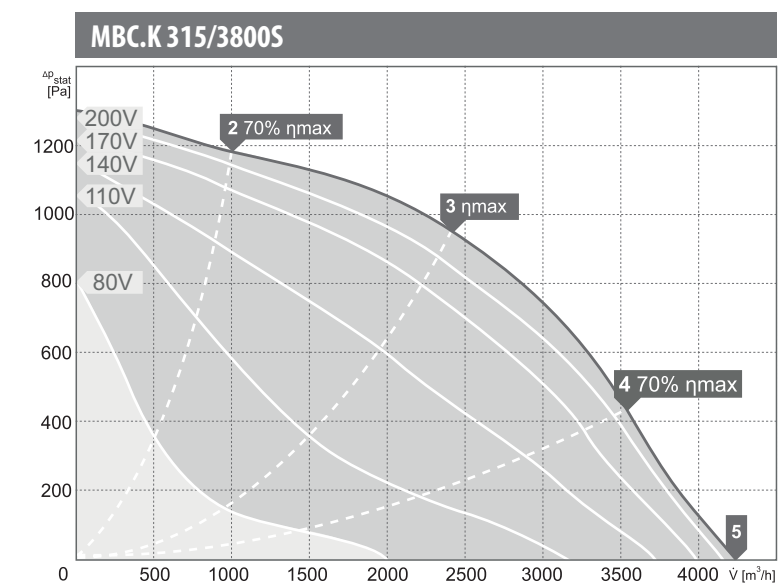
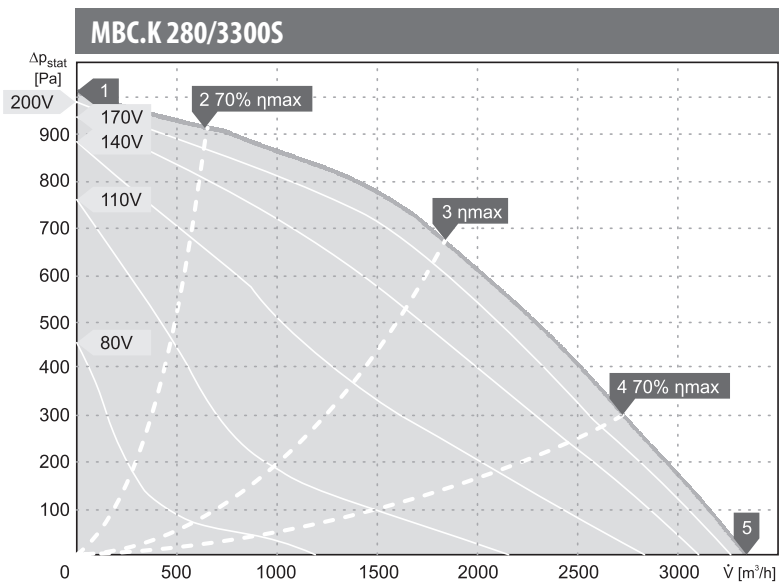
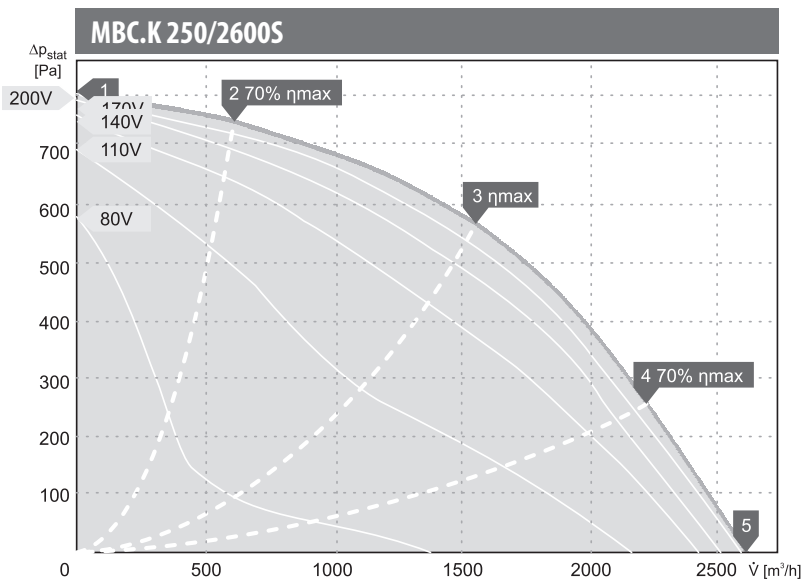

wartości mocy akustycznej  $L_{WA}$  [dB(A)]  
dla poszczególnych częstotliwości pasm oktaowych [Hz]

Pkt. Pracy	Częstotliwości pasm oktaowych [Hz]								
	tot	63	125	250	500	1000	2000	4000	8000
$L_{WA}$ wlot [dB(A)]									
2	77	53	59	67	70	70	70	69	63
3	77	54	57	67	71	70	70	68	63
4	80	55	56	71	75	73	73	72	64
5	83	51	59	74	77	75	75	74	72
$L_{WA}$ wylot [dB(A)]									
2	80	59	63	72	72	74	74	70	65
3	79	53	56	70	71	74	74	70	65
4	83	53	57	74	75	77	78	75	69
5	85	59	61	75	77	79	80	78	73
$L_{WA}$ od obudowy [dB(A)]									
2	73	61	58	59	64	67	67	66	61
3	73	62	57	60	66	68	67	65	60
4	73	65	55	62	65	68	67	64	59
5	75	61	58	64	68	70	69	65	60

Pkt. Pracy	Częstotliwości pasm oktaowych [Hz]								
	tot	63	125	250	500	1000	2000	4000	8000
$L_{WA}$ wlot [dB(A)]									
2	81	55	70	74	75	74	74	72	67
3	80	54	62	70	73	72	73	71	66
4	82	57	65	75	78	75	74	71	65
5	85	55	66	77	81	78	78	75	69
$L_{WA}$ wylot [dB(A)]									
2	82	57	71	76	75	76	76	71	63
3	82	59	63	74	74	76	76	72	64
4	86	57	67	77	79	81	80	74	66
5	88	55	67	79	81	83	83	78	72
$L_{WA}$ od obudowy [dB(A)]									
2	78	57	66	68	68	70	71	70	66
3	75	53	59	64	66	69	70	68	64
4	76	56	61	69	69	69	69	65	61
5	77	60	63	71	71	71	70	66	62

Pkt. Pracy	Częstotliwości pasm oktaowych [Hz]								
	tot	63	125	250	500	1000	2000	4000	8000
$L_{WA}$ wlot [dB(A)]									
2	85	58	74	79	79	76	76	74	67
3	83	50	59	74	77	75	77	76	69
4	86	54	63	79	80	79	79	77	70
5	89	53	67	81	84	82	80	78	72
$L_{WA}$ wylot [dB(A)]									
2	88	57	74	83	80	80	79	75	68
3	85	51	63	79	77	79	78	74	68
4	89	51	67	84	82	84	82	76	68
5	91	53	68	82	85	86	84	79	74
$L_{WA}$ od obudowy [dB(A)]									
2	78	59	74	69	67	68	68	66	60
3	74	52	61	66	66	68	68	65	60
4	76	55	64	70	68	69	69	65	59
5	78	58	64	73	70	70	70	66	59

charakterystyki pracy

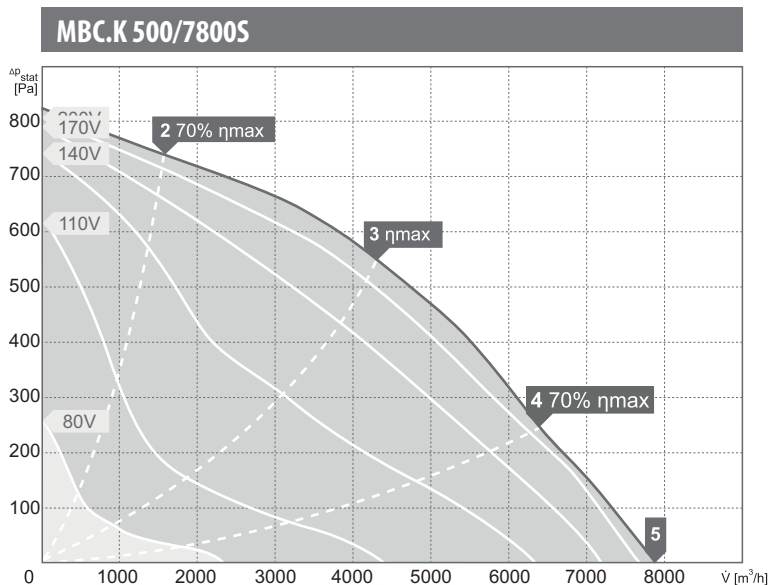
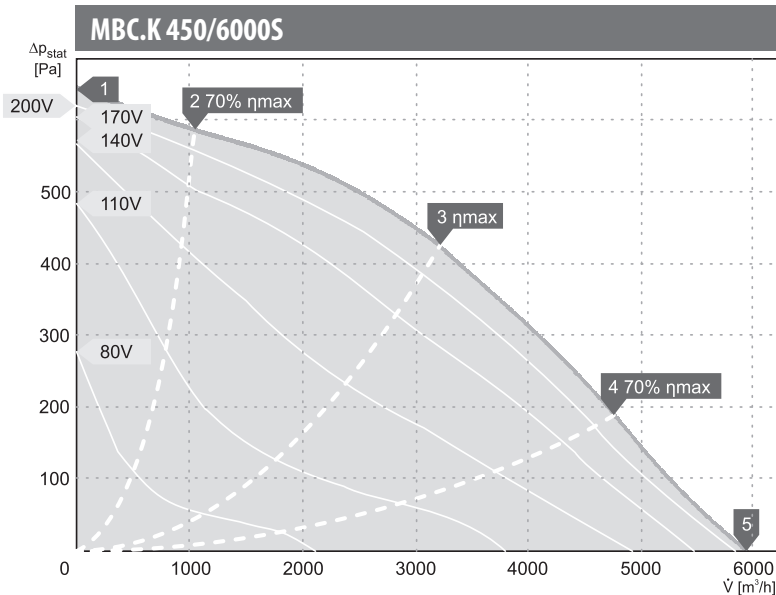
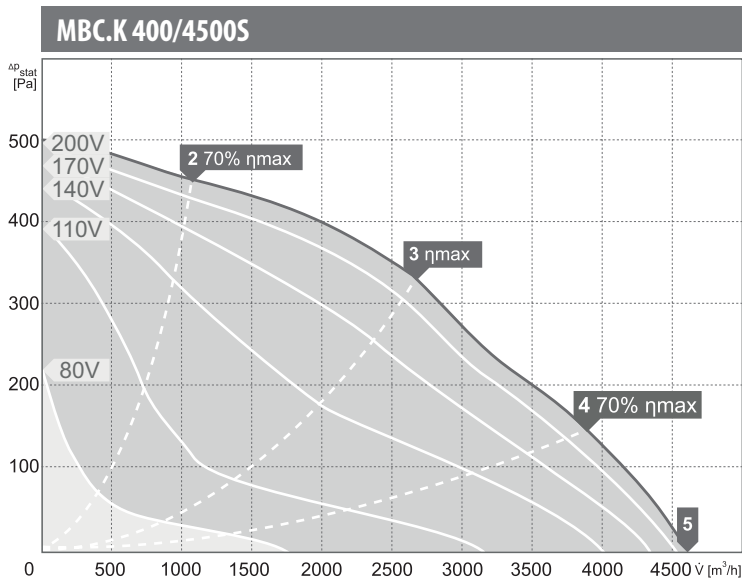

wartości mocy akustycznej  $L_{WA}$  [dB(A)]  
dla poszczególnych częstotliwości pasm oktaowych [Hz]

Pkt. Pracy	Częstotliwości pasm oktaowych [Hz]								
	tot	63	125	250	500	1000	2000	4000	8000
$L_{WA}$ wlot [dB(A)]									
2	72	51	65	64	66	64	62	58	52
3	71	40	63	63	66	64	62	58	54
4	76	42	69	68	71	69	67	63	61
5	79	44	72	70	73	71	70	68	64
$L_{WA}$ wylot [dB(A)]									
2	75	53	67	65	68	70	65	60	57
3	74	40	61	61	67	70	66	61	58
4	77	44	67	67	72	73	68	64	62
5	81	46	69	71	74	76	72	71	65
$L_{WA}$ od obudowy [dB(A)]									
2	65	53	62	53	58	56	53	52	47
3	63	40	60	51	57	56	51	50	43
4	65	44	63	55	57	56	51	48	41
5	67	47	63	58	58	57	54	51	43

Pkt. Pracy	Częstotliwości pasm oktaowych [Hz]								
	tot	63	125	250	500	1000	2000	4000	8000
$L_{WA}$ wlot [dB(A)]									
2	76	53	68	67	69	69	67	63	58
3	76	46	69	67	71	70	67	62	61
4	80	48	72	72	74	73	70	64	63
5	83	50	76	75	76	76	74	69	66
$L_{WA}$ wylot [dB(A)]									
2	79	55	70	69	73	75	71	66	56
3	79	47	68	69	74	75	71	66	57
4	82	49	73	73	77	77	72	67	60
5	86	52	78	77	80	81	77	74	65
$L_{WA}$ od obudowy [dB(A)]									
2	70	54	62	59	63	65	60	59	56
3	70	53	63	60	64	64	60	56	58
4	72	55	67	63	66	65	59	53	48
5	74	58	70	65	67	66	59	53	43

Pkt. Pracy	Częstotliwości pasm oktaowych [Hz]								
	tot	63	125	250	500	1000	2000	4000	8000
$L_{WA}$ wlot [dB(A)]									
2	81	60	76	72	74	74	74	69	61
3	80	49	69	71	74	74	73	69	61
4	83	53	75	75	77	77	74	69	66
5	85	54	77	76	78	78	77	73	68
$L_{WA}$ wylot [dB(A)]									
2	85	60	79	74	79	80	77	72	63
3	84	49	73	72	78	78	76	72	63
4	87	53	76	77	82	82	77	72	66
5	89	55	79	78	83	83	80	76	68
$L_{WA}$ od obudowy [dB(A)]									
2	73	61	69	66	64	61	59	61	56
3	71	54	66	63	64	60	59	59	54
4	74	58	71	67	67	62	60	59	54
5	77	60	74	69	69	65	62	61	55

charakterystyki pracy

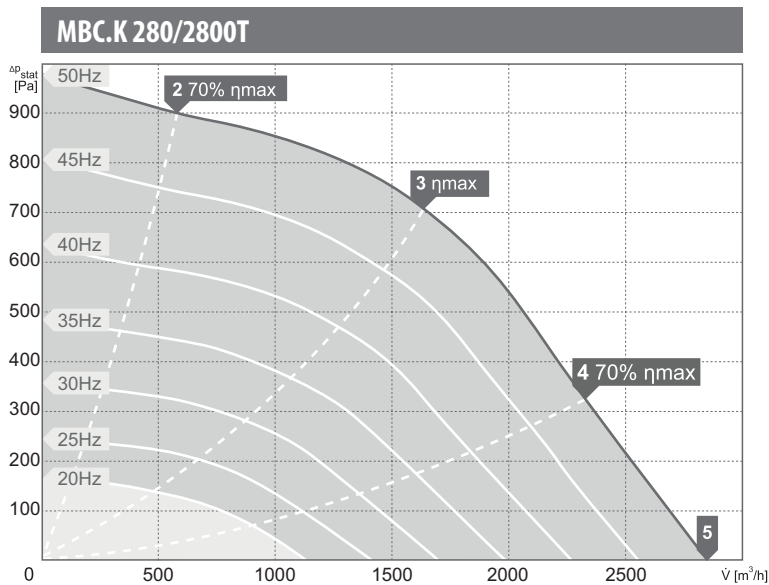
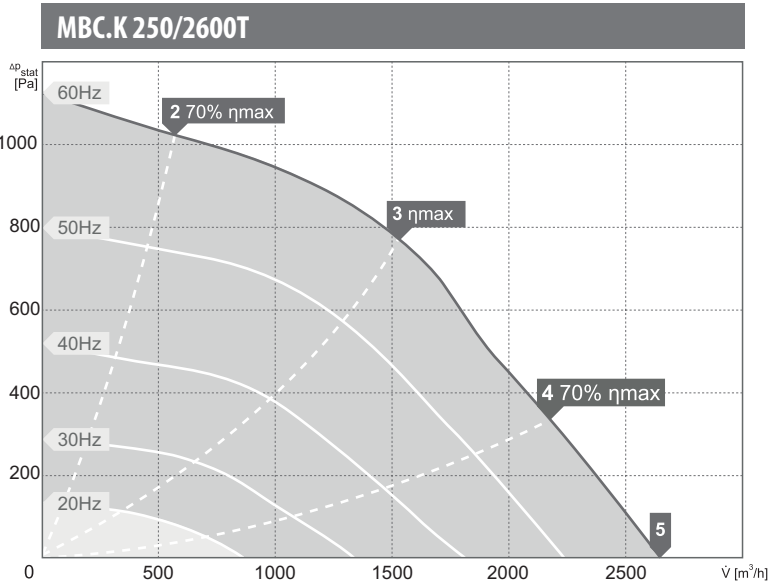
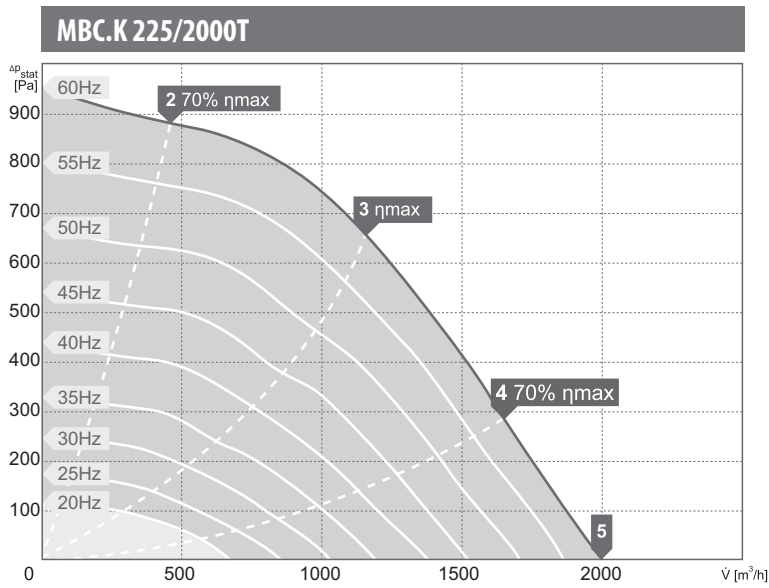

wartości mocy akustycznej  $L_{WA}$  [dB(A)]  
dla poszczególnych częstotliwości pasm oktaowych [Hz]

Pkt. Pracy	tot	Częstotliwości pasm oktaowych [Hz]							
		63	125	250	500	1000	2000	4000	8000
$L_{WA}$ wlot [dB(A)]									
2	80	53	68	71	73	75	72	69	62
3	80	51	63	67	73	77	73	70	63
4	84	51	63	74	76	81	75	73	69
5	85	49	66	76	79	81	77	75	73
$L_{WA}$ wylot [dB(A)]									
2	82	52	69	74	76	76	76	70	63
3	83	47	66	70	77	78	78	71	63
4	87	46	66	76	80	81	82	76	71
5	88	49	68	76	81	82	84	79	75
$L_{WA}$ od obudowy [dB(A)]									
2	74	52	66	61	66	68	69	64	57
3	73	49	61	58	65	68	69	63	56
4	74	48	62	61	67	68	69	64	56
5	75	52	66	64	68	69	70	65	58

Pkt. Pracy	tot	Częstotliwości pasm oktaowych [Hz]							
		63	125	250	500	1000	2000	4000	8000
$L_{WA}$ wlot [dB(A)]									
2	81	53	70	74	74	76	72	69	62
3	82	51	64	68	76	78	73	69	62
4	87	51	64	76	81	83	76	74	74
5	88	50	67	74	82	83	79	77	77
$L_{WA}$ wylot [dB(A)]									
2	84	57	73	78	79	78	77	71	63
3	84	52	68	73	79	79	78	71	63
4	88	49	65	78	83	83	83	75	72
5	89	50	67	78	83	84	84	78	77
$L_{WA}$ od obudowy [dB(A)]									
2	75	56	69	63	65	67	68	63	57
3	73	56	62	59	66	68	68	63	56
4	74	53	63	64	68	68	69	63	56
5	75	50	66	64	69	68	69	64	58

Pkt. Pracy	tot	Częstotliwości pasm oktaowych [Hz]							
		63	125	250	500	1000	2000	4000	8000
$L_{WA}$ wlot [dB(A)]									
2	81	58	73	76	74	73	72	69	66
3	82	50	66	73	77	74	74	70	68
4	86	50	71	81	81	79	76	72	69
5	88	53	71	82	84	81	79	76	71
$L_{WA}$ wylot [dB(A)]									
2	84	59	73	79	77	77	77	71	65
3	85	54	68	77	78	80	78	70	65
4	89	54	72	82	82	83	81	73	68
5	91	55	73	84	85	86	84	77	73
$L_{WA}$ od obudowy [dB(A)]									
2	74	58	69	65	62	66	65	60	55
3	73	51	62	65	62	69	65	60	54
4	74	52	67	69	66	68	65	60	54
5	77	57	69	72	69	68	68	62	55

charakterystyki pracy

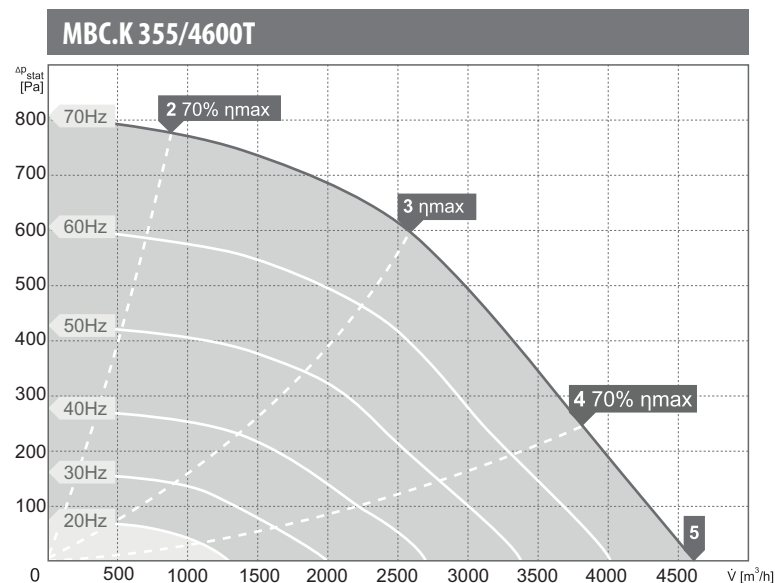
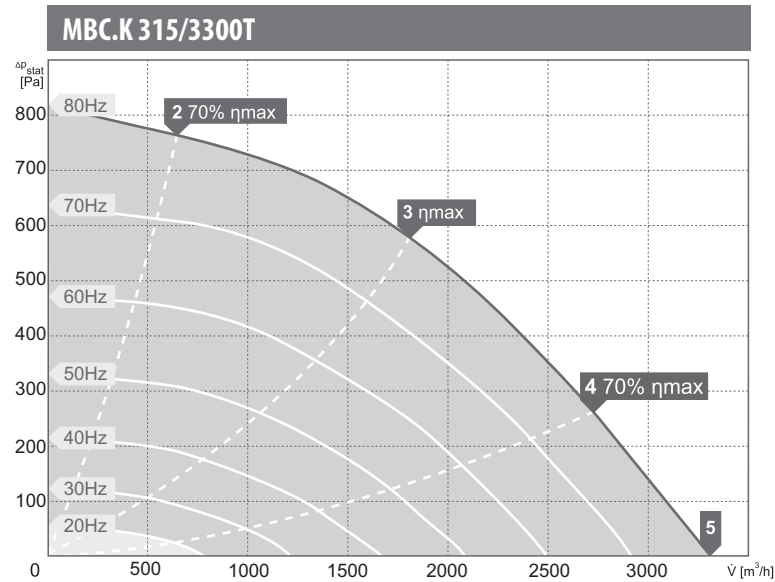
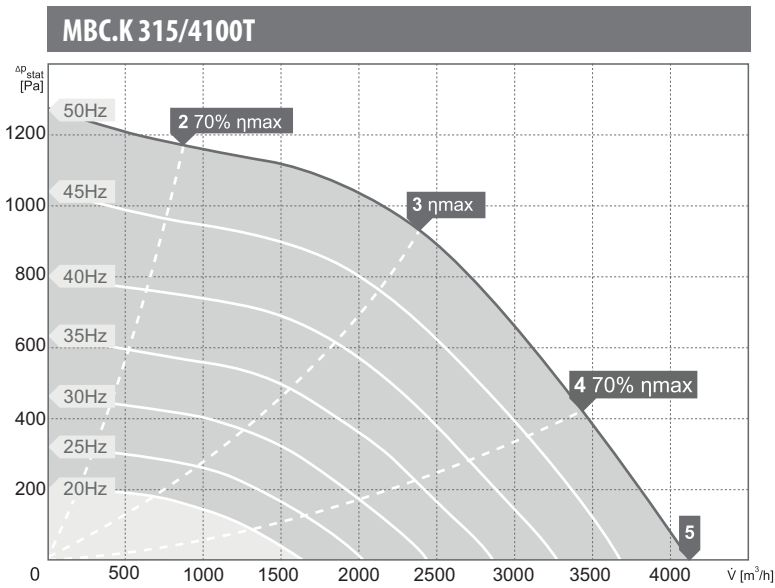

wartości mocy akustycznej  $L_{WA}$  [dB(A)]  
dla poszczególnych częstotliwości pasm oktaowych [Hz]

Pkt. Pracy	Częstotliwości pasm oktaowych [Hz]								
	tot	63	125	250	500	1000	2000	4000	8000
$L_{WA}$ wlot [dB(A)]									
2	85	59	76	80	79	76	76	74	69
3	85	51	66	77	80	78	78	75	71
4	89	52	69	83	84	82	80	77	72
5	90	53	70	82	85	83	83	82	75
$L_{WA}$ wylot [dB(A)]									
2	88	60	74	83	81	81	80	76	70
3	88	56	66	82	81	83	82	78	73
4	92	55	70	85	85	87	85	79	74
5	93	58	72	87	86	88	86	82	77
$L_{WA}$ od obudowy [dB(A)]									
2	76	61	71	68	65	67	67	65	59
3	75	55	63	69	66	68	68	64	58
4	78	57	67	74	69	70	69	65	58
5	79	59	68	75	71	70	71	68	60

Pkt. Pracy	Częstotliwości pasm oktaowych [Hz]								
	tot	63	125	250	500	1000	2000	4000	8000
$L_{WA}$ wlot [dB(A)]									
2	79	55	67	73	73	70	70	68	62
3	78	47	59	70	73	70	71	68	64
4	82	45	63	75	77	75	73	69	66
5	83	47	62	74	79	76	76	74	68
$L_{WA}$ wylot [dB(A)]									
2	82	56	68	76	74	75	74	68	61
3	81	48	60	74	74	76	75	70	64
4	85	45	62	75	78	80	78	72	66
5	86	48	64	78	80	82	80	75	69
$L_{WA}$ od obudowy [dB(A)]									
2	69	58	64	62	59	59	62	55	48
3	68	51	58	59	60	58	64	54	49
4	69	47	59	60	62	60	65	55	50
5	70	48	61	62	63	61	64	57	50

Pkt. Pracy	Częstotliwości pasm oktaowych [Hz]								
	tot	63	125	250	500	1000	2000	4000	8000
$L_{WA}$ wlot [dB(A)]									
2	79	53	66	70	76	70	69	67	61
3	79	43	56	69	76	70	71	68	63
4	83	44	62	76	80	75	74	73	66
5	86	48	63	77	82	77	78	76	71
$L_{WA}$ wylot [dB(A)]									
2	83	59	71	74	79	77	74	70	67
3	84	45	58	72	80	78	75	72	70
4	86	49	64	75	82	81	78	74	70
5	89	52	66	79	84	83	81	79	73
$L_{WA}$ od obudowy [dB(A)]									
2	76	52	64	61	76	63	63	55	53
3	76	43	54	57	76	64	65	56	53
4	78	45	59	61	78	67	66	58	56
5	80	48	62	64	79	70	68	62	56

charakterystyki pracy

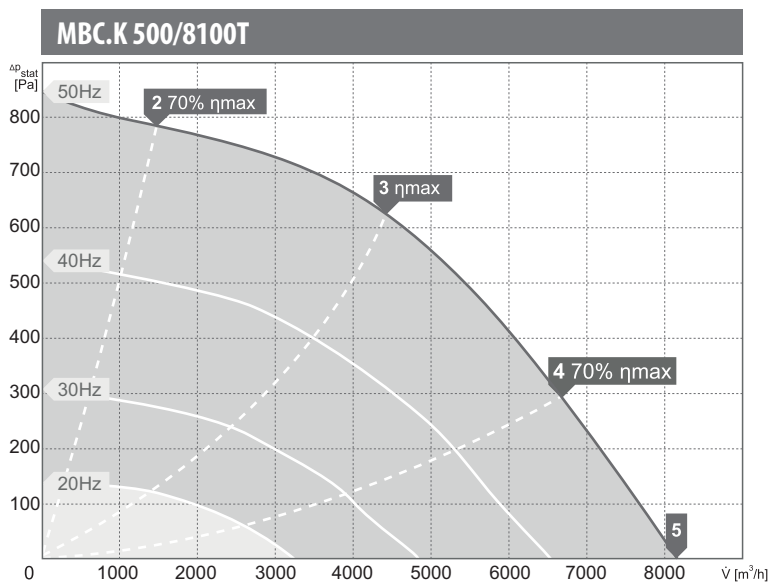
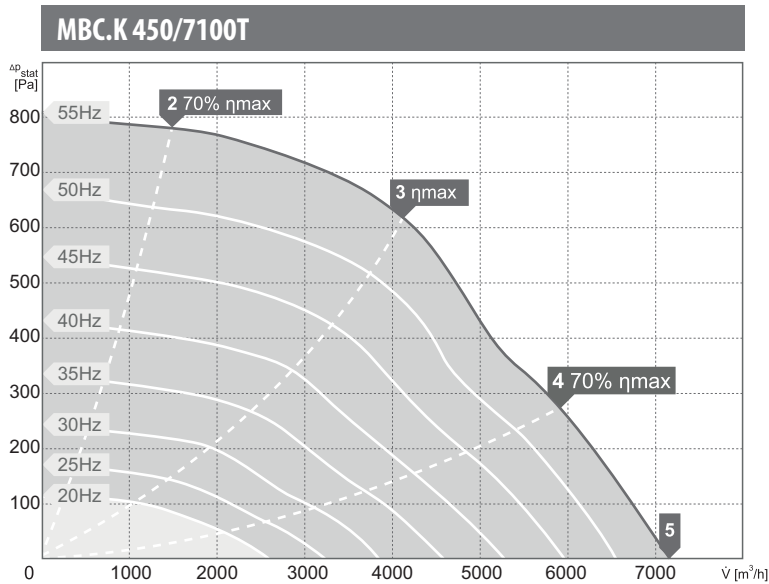
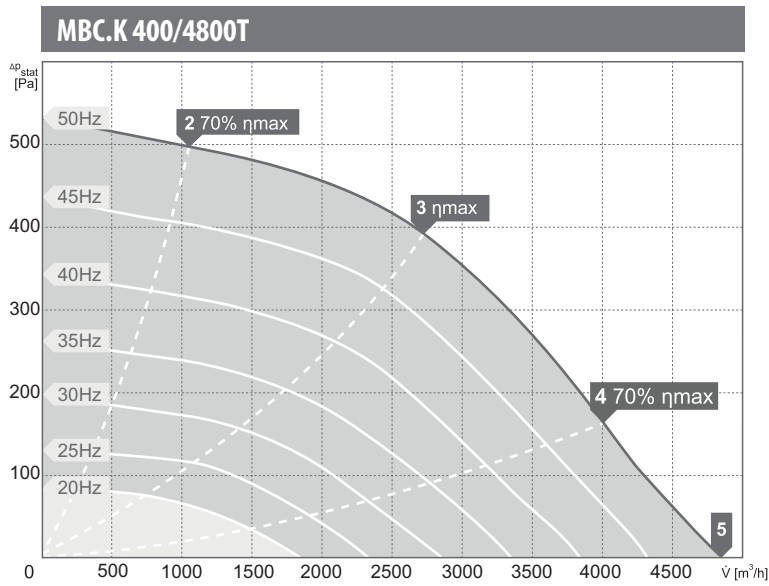

wartości mocy akustycznej  $L_{WA}$  [dB(A)]  
dla poszczególnych częstotliwości pasm oktaowych [Hz]

Pkt. Pracy	Częstotliwości pasm oktaowych [Hz]								
	tot	63	125	250	500	1000	2000	4000	8000
$L_{WA}$ wlot [dB(A)]									
2	73	48	64	64	69	66	63	60	57
3	74	41	67	65	70	66	63	60	58
4	78	45	71	70	73	70	68	69	61
5	80	46	72	71	73	71	71	73	64
$L_{WA}$ wylot [dB(A)]									
2	75	52	66	65	69	70	66	61	56
3	76	41	65	66	70	71	67	62	57
4	80	44	68	70	74	75	71	70	59
5	82	44	70	73	75	77	74	75	63
$L_{WA}$ od obudowy [dB(A)]									
2	69	50	60	58	66	60	52	45	40
3	69	41	61	59	66	61	54	45	38
4	69	45	63	60	65	61	54	48	38
5	70	47	66	61	64	59	55	52	41

Pkt. Pracy	Częstotliwości pasm oktaowych [Hz]								
	tot	63	125	250	500	1000	2000	4000	8000
$L_{WA}$ wlot [dB(A)]									
2	80	55	69	72	74	74	73	70	64
3	82	51	67	75	76	75	73	69	65
4	85	54	72	80	80	78	76	71	68
5	87	53	72	80	81	80	80	77	71
$L_{WA}$ wylot [dB(A)]									
2	83	55	70	74	77	78	76	72	63
3	85	51	67	77	79	80	76	72	64
4	88	53	71	79	83	84	80	76	66
5	90	55	72	81	84	85	82	79	68
$L_{WA}$ od obudowy [dB(A)]									
2	72	56	65	65	66	64	62	59	54
3	73	54	64	68	67	65	62	59	54
4	76	58	69	72	71	67	63	59	51
5	77	62	71	73	71	67	66	61	53

Pkt. Pracy	Częstotliwości pasm oktaowych [Hz]								
	tot	63	125	250	500	1000	2000	4000	8000
$L_{WA}$ wlot [dB(A)]									
2	85	60	75	75	79	80	79	74	64
3	86	51	75	74	79	80	79	74	64
4	88	55	77	77	83	83	80	75	67
5	90	56	78	79	85	85	82	78	68
$L_{WA}$ wylot [dB(A)]									
2	86	63	76	75	80	81	80	75	65
3	86	52	77	75	80	81	79	74	65
4	88	55	77	77	83	83	80	75	67
5	90	57	79	80	85	85	82	78	68
$L_{WA}$ od obudowy [dB(A)]									
2	77	60	71	69	68	70	69	62	52
3	77	51	70	69	70	71	70	63	53
4	79	56	74	71	73	73	71	64	55
5	81	59	75	72	74	74	72	66	56

charakterystyki pracy

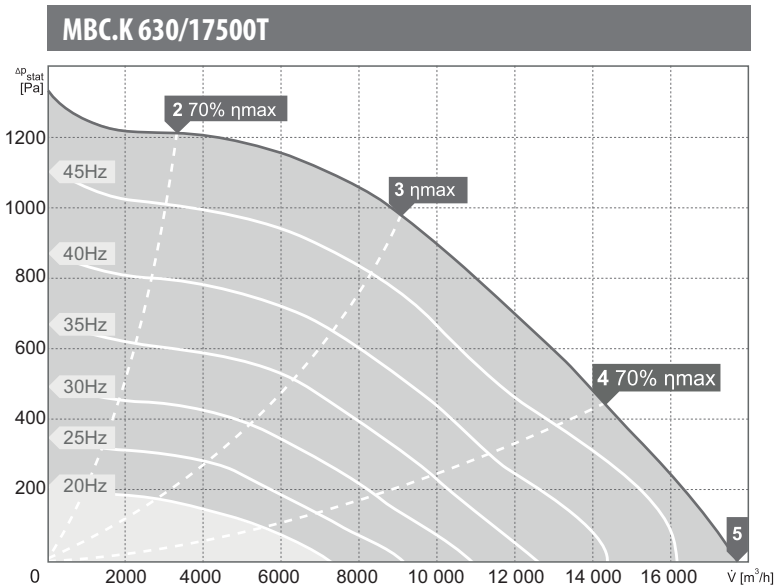
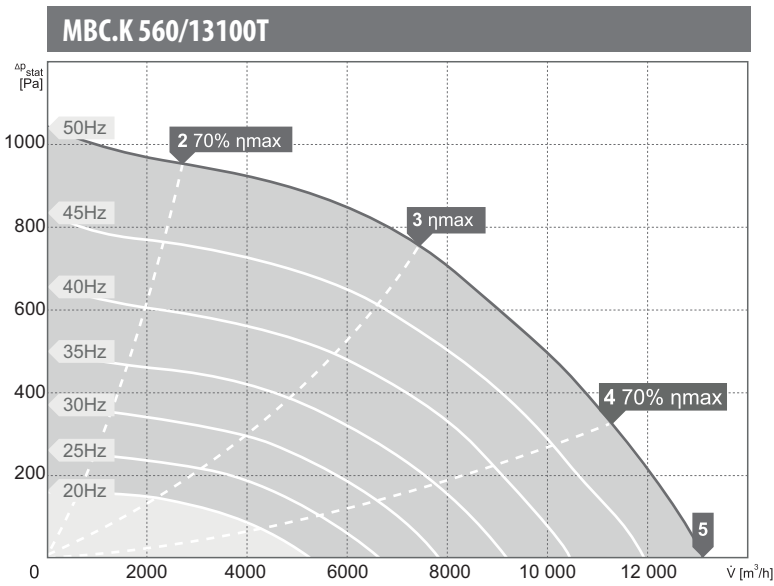

wartości mocy akustycznej  $L_{WA}$  [dB(A)]  
dla poszczególnych częstotliwości pasm oktaowych [Hz]

Pkt. Pracy	Częstotliwości pasm oktaowych [Hz]								
	tot	63	125	250	500	1000	2000	4000	8000
$L_{WA}$ wlot [dB(A)]									
2	84	60	74	74	76	78	77	72	65
3	85	52	77	77	77	79	79	74	67
4	90	54	83	83	82	82	82	78	70
5	91	55	83	84	82	83	84	80	71
$L_{WA}$ wylot [dB(A)]									
2	88	64	77	77	82	83	80	75	67
3	88	49	77	78	82	83	81	77	68
4	91	54	80	82	86	86	83	79	70
5	93	56	84	84	87	88	85	83	71
$L_{WA}$ od obudowy [dB(A)]									
2	75	59	70	67	68	68	62	58	50
3	76	47	66	65	72	73	63	58	50
4	78	51	73	69	73	71	64	60	51
5	79	54	75	71	71	70	66	63	53

Pkt. Pracy	Częstotliwości pasm oktaowych [Hz]								
	tot	63	125	250	500	1000	2000	4000	8000
$L_{WA}$ wlot [dB(A)]									
2	88	65	79	80	80	82	80	74	67
3	89	58	78	81	81	83	81	75	67
4	92	61	84	85	85	86	84	79	70
5	93	60	84	86	86	86	85	81	71
$L_{WA}$ wylot [dB(A)]									
2	92	68	83	82	86	86	83	77	68
3	92	61	81	82	87	87	84	79	70
4	97	61	85	86	91	92	91	86	75
5	98	62	85	87	92	93	92	88	76
$L_{WA}$ od obudowy [dB(A)]									
2	81	65	78	71	70	71	70	62	54
3	79	57	76	71	71	71	70	62	55
4	84	60	80	76	75	75	74	66	58
5	84	62	80	76	76	77	76	69	58