

**NOWE
MODELE**



konstrukcja

Wentylator promieniowy przeznaczony głównie do stosowania w wyciągach kuchennych. Obudowa wykonana z galwanizowanej blachy stalowej, izolowana termicznie i akustycznie wełną mineralną o grubości 40 mm, posiada łatwo otwierane drzwi inspekcyjne, na których zamontowany jest układ silnik-wirnik, co pozwala na łatwe czyszczenie wnętrza wentylatora. Elastyczne uszczelki i odpowiednia konstrukcja pozwalają osiągnąć najwyższą klasę szczelności obudowy L1 (wg. EN 1886). Obudowa została zaprojektowana

tak, aby ułatwić odprowadzanie skroplin z wnętrza wentylatora poprzez odpływ drenażowy 3/4" (pod warunkiem instalacji wentylatora wylotem w górę, ponadto instalacja powinna być wyposażona w stosowne filtry / łapacze tłuszczu). W komplecie dostarczane są gumowe wibroizolatory oraz szyny wspornikowe ułatwiające montaż na konsoli wsporczej.

wirnik

Wirnik nowej generacji wyważony dynamicznie w klasie G2.5, typu B – z łopatkami pochylonymi do tyłu, wykonany z blachy stalowej malowanej proszkowo. Kształt łopatek pozwala utrzymać najwyższe parametry pracy przez cały okres użytkowania wentylatora.

napęd i sterowanie

Jednofazowy (230V, 50Hz, IP54, klasa izolacji F) lub trójfazowy (400V, 50Hz, IP55, klasa izolacji F) asynchroniczny silnik elektryczny zlokalizowany całkowicie poza strumieniem usuwanego powietrza.

Prędkość obrotowa modeli jednofazowych może być kontrolowana przy pomocy regulatorów transformatorowych. Zalecany zakres regulacji napięcia 110-230V. Silniki te posiadają czujniki temperatury uzwojeń typu termokontakt, które muszą być podłączone i monitorowane przez zewnętrzne urządzenie ochrony termicznej, np. automatykę, przekaźnik wbudowany w regulator, przekaźnik SET10 itp.

Prędkość obrotowa modeli z silnikami trójfazowymi (3x230V/3x400V) może być kontrolowana za pomocą przemienników częstotliwości, wyłącznie w zakresie częstotliwości (obrotów) podanych w tabeli/wykresie doboru. Zalecany czas przyspieszania i hamowania przetwornicą (rampa): 20-30 sek.

W przypadku bezpośredniego podłączania silników trójfazowych do sieci należy je zabezpieczyć przy pomocy wyłączników silnikowych z wbudowanym wyzwalaczem zwarciowym i przeciążeniowym.

Nastawa wyzwalacza termicznego wyłącznika silnikowego musi być dostosowana do rzeczywistych parametrów pracy wentylatora i nie wyższa niż wartość I_{max} dla wentylatora.

maksymalna temperatura pracy

temperatura otoczenia: 40 ÷ 80°C – w zależności od wybranego modelu temperatura medium: 120°C.

zastosowanie

Efektywny odciąg oparów z kuchni przemysłowych w obiektach gastronomicznych. Możliwość zastosowania we wszelkich instalacjach odciągowych do przetłaczania powietrza o podwyższonej temperaturze.

Akcesoria



GS
wyłącznik serwisowy
str. nr 548



STR-1
5-bieg. reg. ob. (transformatorowy)
str. nr 533



STRS-1
5-bieg. reg. ob. (transformator.) TK
str. nr 533



STRS-4
5-bieg. reg. ob. (transformator.) TK
str. nr 537



WKS
konsola wsporcza
str. nr 288



WSH
osłona silnika
str. nr 288

100% HIGIENY



Łatwa w czyszczeniu konstrukcja, specjalnie zaprojektowany wirnik oraz drenaż w dolnej części obudowy sprawiają, że utrzymanie wentylatora w czystości jest niezwykle łatwe.

100% WYGODY

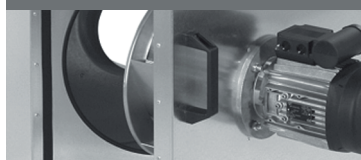

Wysokowydajny wirnik oraz wibroizolatory zapewniają komfortową pracę przy relatywnie niskim poziomie hałasu, a ergonomiczne uchwyty i doskonale wyważone uchylne drzwi sprawiają, że konserwacja zajmuje minimum czasu.

100% SKUTECZNOŚCI

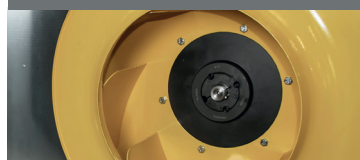

Nowoczesny wirnik, odizolowany silnik i optymalny kształt obudowy sprawiają, że wentylator zachowuje wysokie parametry pracy dla odciągów z kuchni przemysłowych i innych instalacji gastronomicznych.

120°C

Wysoko-temperaturowy

Wentylator przystosowany do wyciągu medium o temperaturze do 120°C w warunkach pracy ciągłej.

tablica doboru akcesoriów dla danego wentylatora COOKVENT

Typ COOKVENT	200/1500	250/2500	315/3400	355/4500	355/4300	355/5800	400/7800
Wyłącznik serwisowy	GS 01	GS 01	GS 01	GS 01	GS 01	GS 01	GS 01
5-bieg. reg. + zabez. termiczne	STR-1-35L22+ SET10	STR-1-50L22+ SET10	STR-1-50L22+ SET10	STR-1-100L22+ SET10	STR-1-35L22 +SET10	STR-1-50L22+S ET10	-
5-bieg. reg. obr. wbudowane zabez. term.	STRS-1-35L22	STRS-1-50L22	STRS-50L22	STRS-1-100L22	STRS-1-35L22	STRS-1-50L22	STRS-1-100L22
Ostłona silnika	WSH	WSH	WSH	WSH	WSH	WSH	WSH
Konsola wsporcza	WKS 07	WKS 07	WKS 07	WKS 07	WKS 07	WKS 07	WKS 08

Typ COOKVENT	200/2000T	250/2700T	315/3400T	355/4500T	355/3600T
Wyłącznik serwisowy	GS 03	GS 03	GS 03	GS 03	GS 03
Wyłącznik silnikowy	1,0 - 1,6 A	1,0 - 1,6 A	1,0 - 1,6 A	2,5 - 4,0 A	1,0 - 1,6 A
Przebiegnik częstotliwości 1x230V/3x230V	SV008IC5-1F	SV008IC5-1F	SV008IC5-1F	SV015IC5-1F	SV008IC5-1F
Przebiegnik częstotliwości 3x400V/3x400V	SV008IG5A-4	SV008IG5A-4	SV008IG5A-4	SV015IG5A-4	SV008IG5A-4
Ostłona silnika	WSH	WSH	WSH	WSH	WSH
Konsola wsporcza	WKS 07	WKS 07	WKS 07	WKS 07	WKS 07

tablica doboru akcesoriów dla danego wentylatora COOKVENT

Typ COOKVENT	355/4300T	355/4400T	355/6700T	400/7900T	500/11800T
Wyłącznik serwisowy	GS 03	GS 03	GS 03	GS 03	GS 03
Wyłącznik silnikowy	1,0 - 1,6 A	1,0 - 1,6 A	2,5 - 4,0 A	2,5 - 4,0 A	4,0 - 6,3 A
Przebiegnik częstotliwości 1x230V/3x230V	SV008iC5-1F	SV008iC5-1F	SV015iC5-1F	SV015iC5-1F	SV022iC5-1F
Przebiegnik częstotliwości 3x400V/3x400V	SV008iG5A-4	SV008iG5A-4	SV015iG5A-4	SV015iG5A-4	SV022iG5A-4
Ośłona silnika	WSH	WSH	WSH	WSH	WSH
Konsola wsporcza	WKS 07	WKS 07	WKS 07	WKS 08	WKS 08

dane techniczne

Typ	\dot{V}_{max} [m³/h]	Δp_{max} [Pa]	P_{max} [W]	U [V]	I _{max} [A]	RPM _{max} [1/min]	t _{max} ¹⁾ [°C]	L _{WA} ²⁾ [dB(A)]	L _{pA} ²⁾ [dB(A)]	m [kg]	nr katalogowy
COOKVENT 200/1500	1460	660	287	1~230	2,3	2900	80	69	46	28,4	13787900
COOKVENT 250/2500	2490	785	448	1~230	3,3	2490	80	71	48	48	12664600
COOKVENT 315/3400	3400	982	722	1~230	4,1	2890	80	74	51	48	12664700
COOKVENT 355/4500	4450	1260	1292	1~230	7,6	2920	50	73	50	54,5	13707900
COOKVENT 355/4300	4250	530	526	1~230	3	1450	80	62	39	61	13800500
COOKVENT 355/5800	5780	640	850	1~230	4,7	1450	50	66	43	67	12665200
COOKVENT 400/7800	7800	815	1505	1~230	8,4	1460	40	72	49	105	13804500

¹⁾ maksymalna temperatura otoczenia przy stosowaniu regulacji

²⁾ poziom ciśnienia akustycznego w odległości 4m od obudowy (pole swobodne)

Typ	V _{max} [m³/h]	Δp _{max} [Pa]	P _{max} [W]	P _{nom} [W]	U [V]	I _{max} [A]	F _{nom} [Hz]	f _{min} - f _{max} [Hz]	RPM _{max} [1/min]	RPM _{nom} [1/min]	t _{max} [°C]	L _{WA} ²⁾ [dB(A)]	L _{pA} ²⁾ [dB(A)]	m [kg]	nr katalogowy
COOKVENT 200/2000T	1960	980	486	486	3~230/400(Δ/Y)	0,91	50	20-60	3530	3440	60	74	61	29,3	14071000
COOKVENT 250/2700T	2730	1130	756	756	3~230/400(Δ/Y)	1,28	50	20-60	3480	3280	60	72	59	38	14071200
COOKVENT 315/3400T	3350	1025	759	759	3~230/400(Δ/Y)	1,34	50	20-50	2920	2780	60	75	62	38,5	14071400
COOKVENT 355/4500T	4520	1300	1221	1221	3~230/400(Δ/Y)	2,42	50	20-50	2950	2860	60	72	59	52,9	14069800
COOKVENT 355/3600T	3580	840	669	669	3~230/400(Δ/Y)	1,18	50	20-80	2360	2280	60	71	58	52,9	14069600
COOKVENT 355/4300T	4350	820	775	775	3~230/400(Δ/Y)	1,36	50	20-70	2060	1970	60	68	55	54,7	14070000
COOKVENT 355/4400T	4450	555	564	564	3~230/400(Δ/Y)	1,12	50	20-50	1480	1450	60	66	53	66,3	14070200
COOKVENT 355/6700T	6660	850	1278	1278	3~230/400(Δ/Y)	2,54	50	20-55	1630	1600	60	74	61	74,9	14070400
COOKVENT 400/7900T	7890	855	1504	1504	3~230/400(Δ/Y)	2,98	50	20-50	1490	1450	60	72	59	112,7	14070800
COOKVENT 500/11800T	11840	1050	2577	2577	3~230/400(Δ/Y)	4,95	50	20-50	1480	1420	60	76	63	115	14111400

²⁾ poziom ciśnienia akustycznego w odległości 4m od obudowy (pole swobodne)

schematy elektryczne

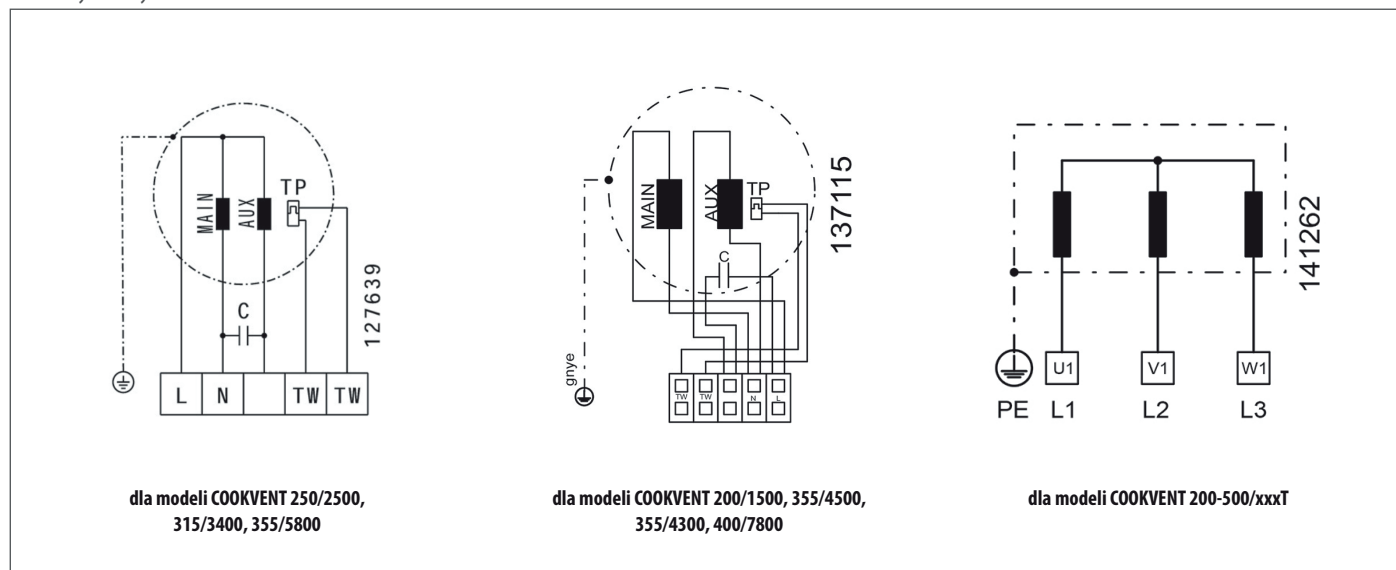

wymiary

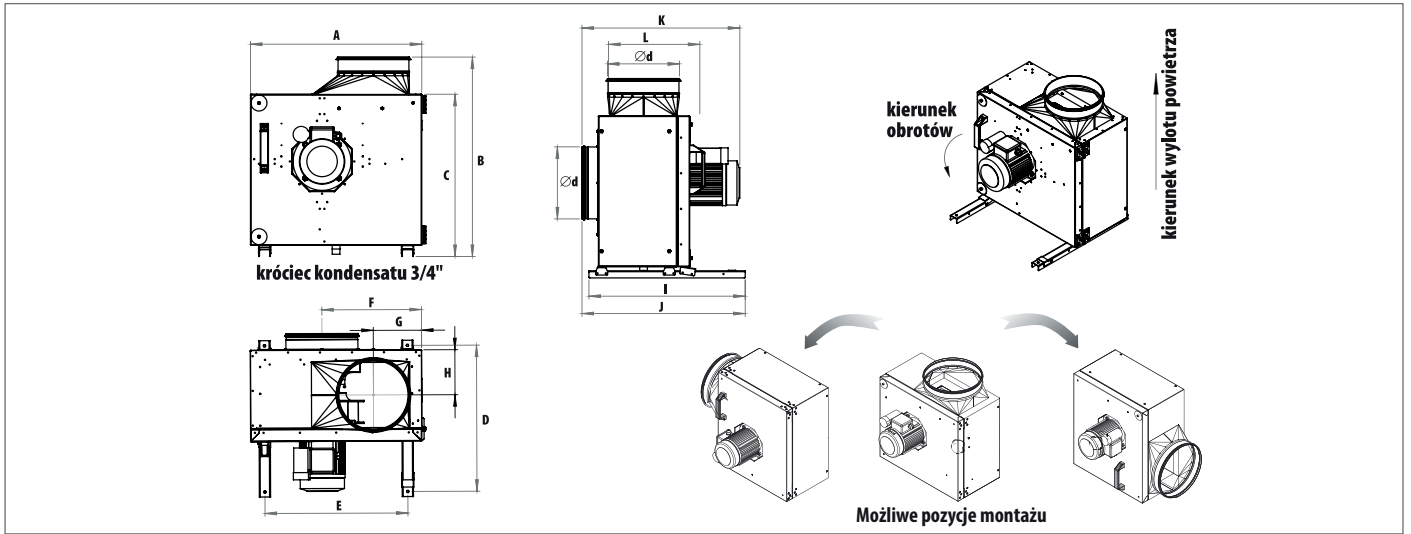

Typ	A [mm]	B [mm]	C [mm]	Ød [mm]	D [mm]	E [mm]	F [mm]	G [mm]	H [mm]	I [mm]	J [mm]	K [mm]	L [mm]
COOKVENT 200/1500	492	571	474	199	445	394	285	142	130	480	485	475	265
COOKVENT 250/2500	592	689	561	249	505	493,5	344	167	156	540	564	545	315
COOKVENT 315/3400	592	689	561	314	505	494	344	200	156	540	564	562	315
COOKVENT 355/4500	700	793	663	354	555	602	405	220	181	590	614	672	365
COOKVENT 355/4300	832	919	789	354	555	734	477	220	181	590	614	595	365
COOKVENT 355/5800	832	919	789	354	555	734	477	220	181	590	614	640	365
COOKVENT 400/7800	1015	1094	954	399	799	917	584	242	253	834	876	828	510
COOKVENT 200/2000T	492	571	474	199	445	394	285	142	131	480	483	481	265
COOKVENT 250/2700T	592	690	561	249	505	494	344	166	156	540	562	550	315
COOKVENT 315/3400T	592	692	561	314	505	494	344	200	156	540	562	550	315
COOKVENT 355/4500T	700	790	663	354	555	602	404	218	181	590	612	616	365
COOKVENT 355/3600T	700	790	663	354	555	602	404	218	181	590	612	616	365
COOKVENT 355/4300T	700	790	663	354	555	602	404	218	181	590	612	616	365
COOKVENT 355/4400T	832	916	789	354	555	734	447	220	181	590	612	616	365
COOKVENT 355/6700T	832	916	789	354	555	734	447	220	181	590	612	659	365
COOKVENT 400/7900T	1016	1092	954	399	799	918	584	242	253	834	876	825	510
COOKVENT 500/11800T	1016	1092	954	499	799	918	584	289	253	834	876	825	510

charakterystyki pracy

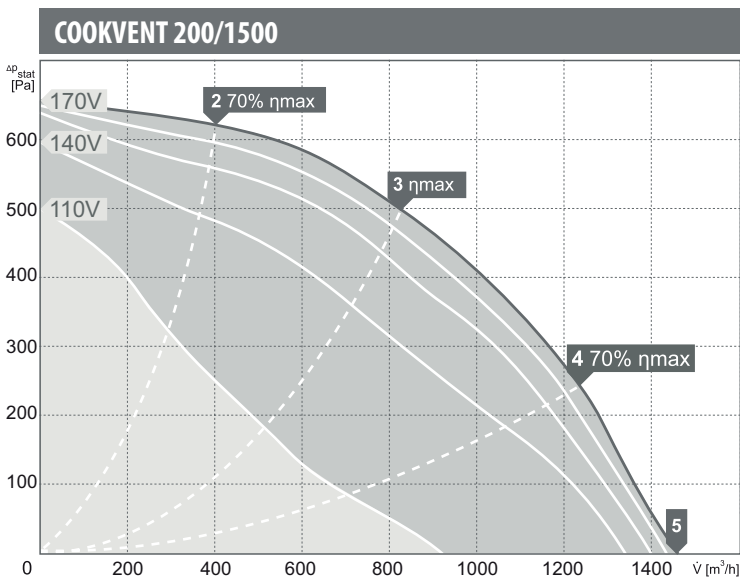

wartości mocy akustycznej L_{WA} [dB(A)]
dla poszczególnych częstotliwości pasm oktaowych [Hz]

Pkt. Pracy	Częstotliwości pasm oktaowych [Hz]								
	tot	63	125	250	500	1000	2000	4000	8000
L_{WA} wlot [dB(A)]									
2	75	43	64	66	69	69	68	65	57
3	74	39	56	64	70	68	66	62	54
4	78	37	61	68	74	72	68	65	57
5	80	40	61	69	75	74	71	70	61
L_{WA} wylot [dB(A)]									
2	75	53	63	68	69	66	69	65	57
3	74	50	59	67	69	66	67	63	54
4	78	49	61	71	73	69	71	66	57
5	79	51	61	69	73	72	74	71	63
L_{WA} od obudowy [dB(A)]									
2	70	48	63	57	58	63	64	61	54
3	69	45	56	55	58	63	64	61	53
4	69	45	60	58	59	63	64	61	53
5	70	45	62	59	60	63	65	61	53

charakterystyki pracy

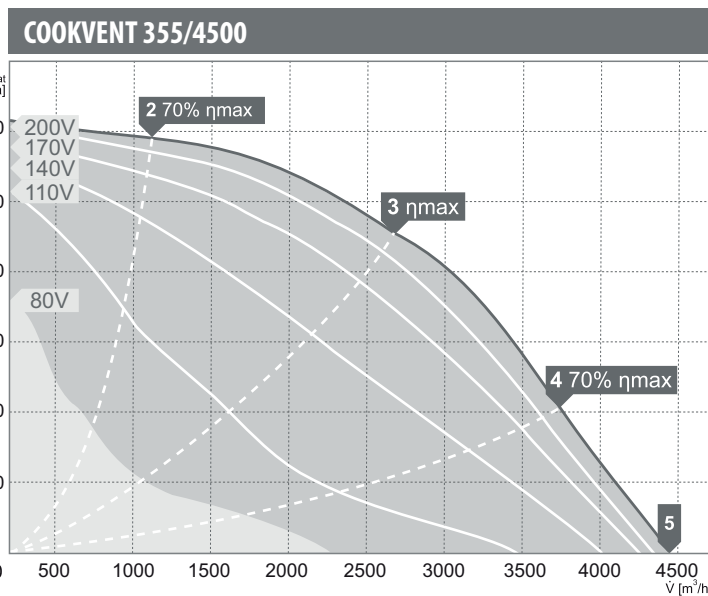
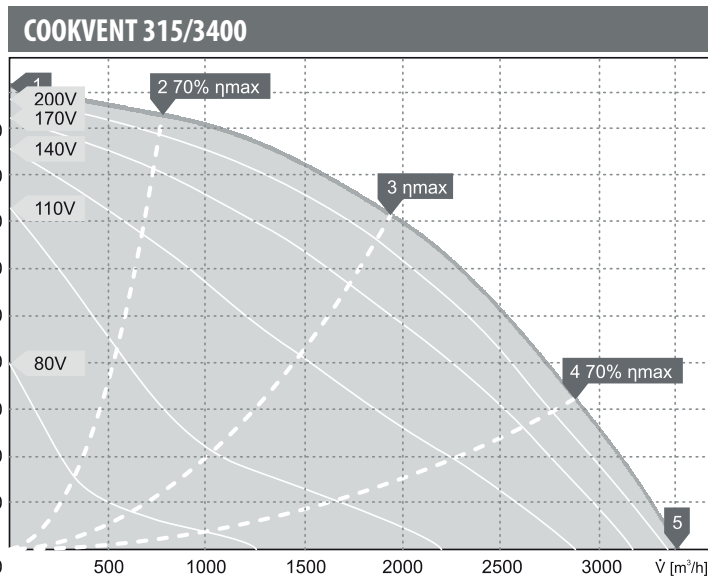
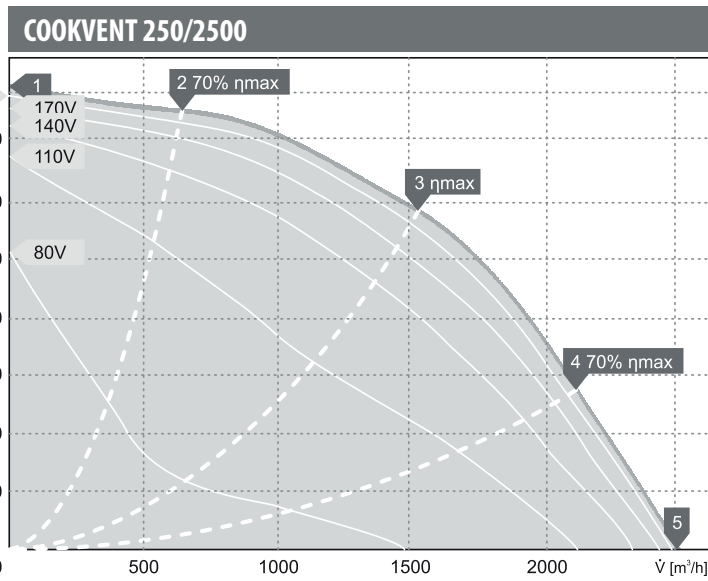

wartości mocy akustycznej L_{WA} [dB(A)]
dla poszczególnych częstotliwości pasm oktaowych [Hz]

Pkt. Pracy	tot	Częstotliwości pasm oktaowych [Hz]							
		63	125	250	500	1000	2000	4000	8000
L_{WA} wlot [dB(A)]									
2	77	44	56	71	70	70	69	68	61
3	78	44	56	73	73	71	69	69	62
4	81	46	59	76	77	74	71	70	63
5	83	48	61	78	79	75	72	71	65
L_{WA} wylot [dB(A)]									
2	79	52	62	73	69	71	73	70	63
3	78	46	57	72	68	71	73	70	64
4	80	44	60	74	70	73	75	71	65
5	83	47	62	76	74	75	76	73	70
L_{WA} od obudowy [dB(A)]									
2	71	43	52	59	58	67	66	65	58
3	71	42	52	60	58	67	66	65	58
4	71	44	54	62	59	66	66	64	57
5	72	48	56	64	60	67	66	65	58

Pkt. Pracy	tot	Częstotliwości pasm oktaowych [Hz]							
		63	125	250	500	1000	2000	4000	8000
L_{WA} wlot [dB(A)]									
2	81	57	71	74	77	75	71	69	64
3	80	54	59	71	75	74	72	70	67
4	83	57	67	75	78	76	74	72	68
5	85	54	66	76	80	79	75	74	70
L_{WA} wylot [dB(A)]									
2	84	59	72	78	75	77	77	74	68
3	83	57	65	75	74	77	77	75	70
4	86	56	65	78	78	81	80	77	72
5	89	56	65	82	80	83	82	79	75
L_{WA} od obudowy [dB(A)]									
2	76	56	63	67	64	72	67	63	58
3	74	50	58	67	63	70	66	62	57
4	75	55	60	69	62	72	66	63	57
5	75	56	59	69	63	72	67	63	58

Pkt. Pracy	tot	Częstotliwości pasm oktaowych [Hz]							
		63	125	250	500	1000	2000	4000	8000
L_{WA} wlot [dB(A)]									
2	84	52	66	79	78	74	74	72	65
3	86	46	61	83	80	76	76	73	67
4	89	46	65	84	83	80	79	76	69
5	91	49	67	87	86	82	82	79	74
L_{WA} wylot [dB(A)]									
2	86	54	69	81	77	79	79	75	67
3	84	48	62	78	75	78	78	75	67
4	88	47	62	80	80	83	82	78	70
5	90	49	65	82	81	84	84	81	75
L_{WA} od obudowy [dB(A)]									
2	75	57	68	66	64	67	68	65	59
3	73	52	62	65	64	66	68	65	58
4	75	55	66	69	66	67	68	65	57
5	76	58	66	70	68	67	69	65	57

charakterystyki pracy

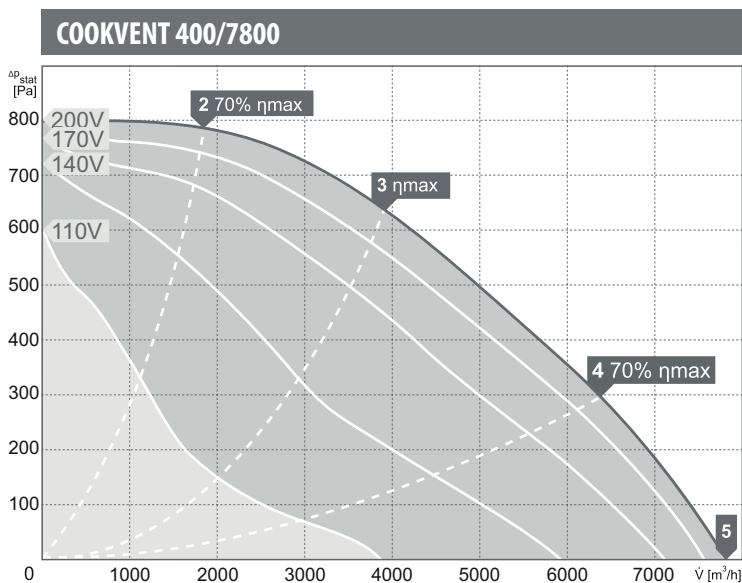
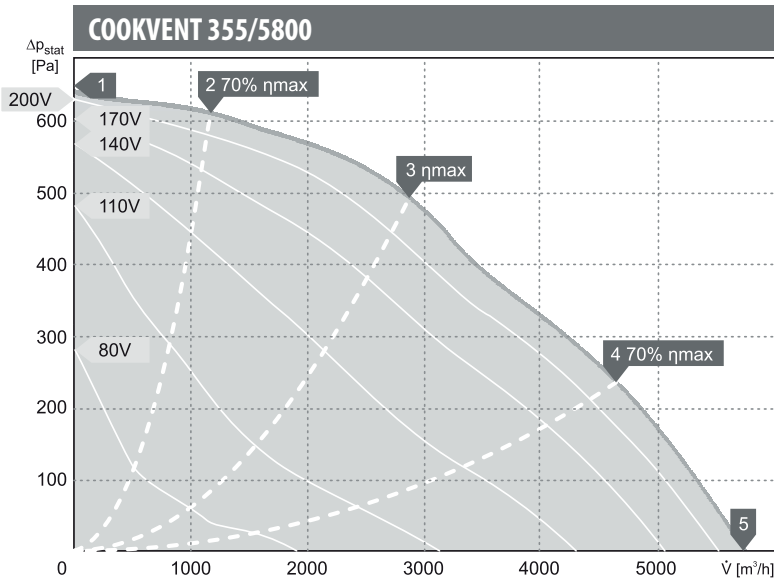
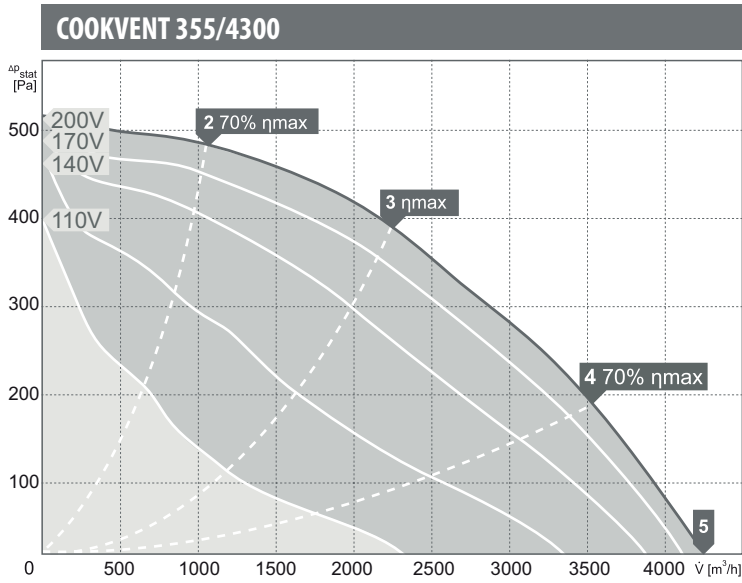

wartości mocy akustycznej L_{WA} [dB(A)]
dla poszczególnych częstotliwości pasm oktaowych [Hz]

Pkt. Pracy	Częstotliwości pasm oktaowych [Hz]								
	tot	63	125	250	500	1000	2000	4000	8000
L_{WA} wlot [dB(A)]									
2	72	52	65	64	67	65	61	59	52
3	70	40	61	64	64	64	61	58	54
4	75	40	66	68	68	68	65	63	58
5	78	45	70	72	72	71	69	67	62
L_{WA} wylot [dB(A)]									
2	73	54	63	65	63	68	66	62	54
3	72	42	60	62	63	67	65	61	57
4	75	44	63	65	66	70	69	65	61
5	79	47	65	69	70	73	73	69	64
L_{WA} od obudowy [dB(A)]									
2	63	51	61	55	53	50	50	47	46
3	62	40	60	56	53	51	50	45	40
4	66	47	64	60	54	52	50	46	39
5	69	51	64	63	55	53	52	48	41

Pkt. Pracy	Częstotliwości pasm oktaowych [Hz]								
	tot	63	125	250	500	1000	2000	4000	8000
L_{WA} wlot [dB(A)]									
2	76	56	68	69	71	68	67	66	58
3	75	50	66	69	68	67	66	65	57
4	77	44	67	71	71	70	68	68	63
5	81	47	72	75	75	74	71	70	65
L_{WA} wylot [dB(A)]									
2	78	55	68	70	68	72	72	68	60
3	76	48	66	68	67	69	69	66	58
4	78	49	69	71	70	71	70	67	59
5	81	50	69	74	73	74	73	71	65
L_{WA} od obudowy [dB(A)]									
2	66	52	63	60	52	56	54	49	43
3	66	49	63	60	51	55	54	47	40
4	69	51	66	66	55	56	54	48	39
5	71	53	67	67	56	56	55	49	40

Pkt. Pracy	Częstotliwości pasm oktaowych [Hz]								
	tot	63	125	250	500	1000	2000	4000	8000
L_{WA} wlot [dB(A)]									
2	80	61	70	73	72	74	70	68	63
3	79	57	69	71	70	74	68	68	62
4	81	53	73	74	74	75	72	70	63
5	84	55	76	77	77	77	75	72	65
L_{WA} wylot [dB(A)]									
2	79	57	70	67	70	75	69	65	58
3	78	53	69	66	69	75	68	65	58
4	81	51	72	70	73	78	71	68	61
5	83	54	75	72	75	78	74	71	63
L_{WA} od obudowy [dB(A)]									
2	73	57	63	59	58	70	60	55	49
3	72	54	62	58	59	70	58	55	48
4	74	46	65	60	63	72	58	56	47
5	74	50	65	64	63	71	59	57	48

charakterystyki pracy

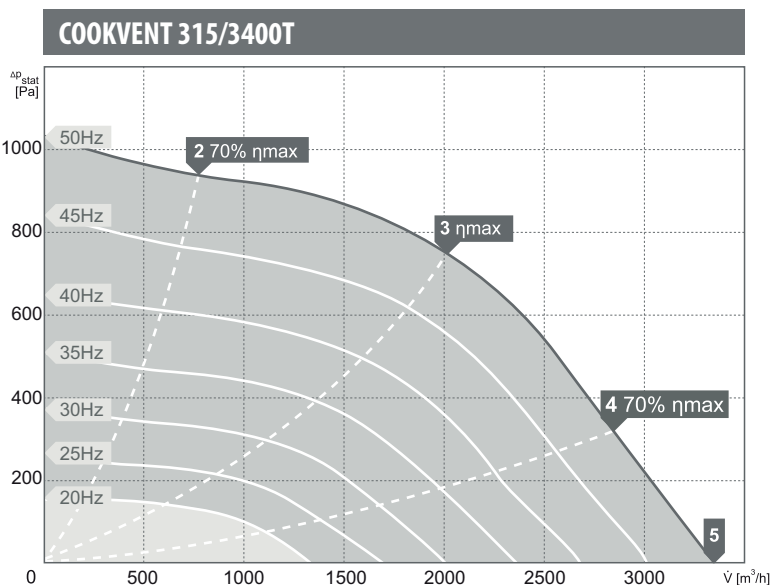
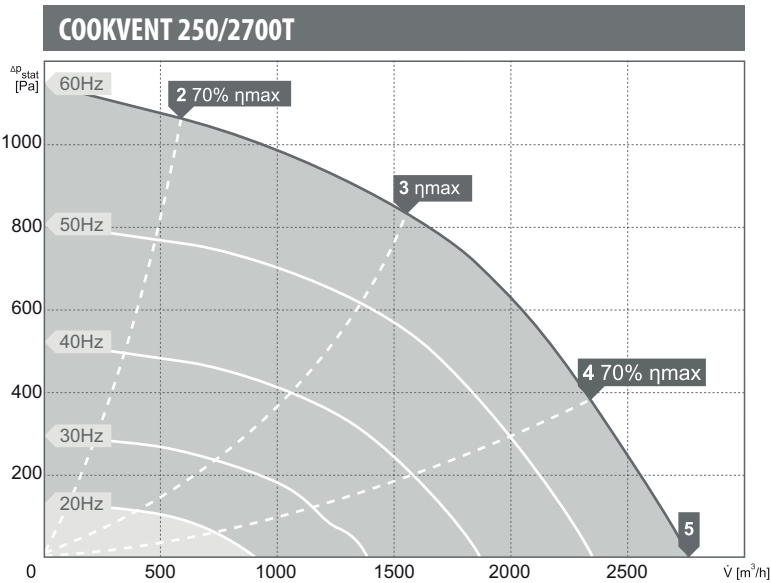
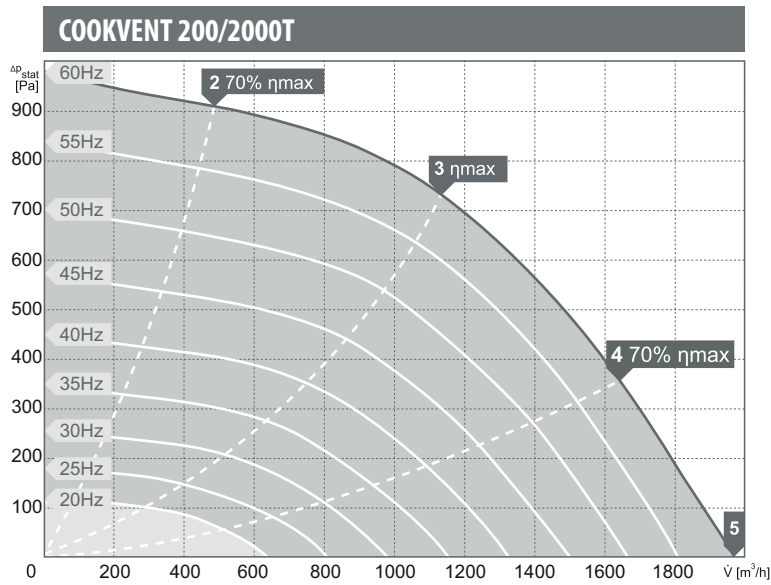

wartości mocy akustycznej L_{WA} [dB(A)]
dla poszczególnych częstotliwości pasm oktaowych [Hz]

Pkt. Pracy	tot	Częstotliwości pasm oktaowych [Hz]							
		63	125	250	500	1000	2000	4000	8000
L_{WA} wlot [dB(A)]									
2	81	48	67	72	76	74	73	71	63
3	79	46	63	66	75	73	72	70	62
4	83	50	62	69	79	77	75	75	66
5	85	48	66	72	80	79	77	77	69
L_{WA} wylot [dB(A)]									
2	83	52	69	71	80	75	77	73	65
3	83	46	64	66	80	75	76	73	65
4	87	46	65	69	83	78	80	77	69
5	88	47	66	70	85	79	81	78	72
L_{WA} od obudowy [dB(A)]									
2	76	52	65	64	66	69	71	66	59
3	74	53	59	60	66	68	70	65	57
4	75	51	62	62	68	69	70	66	58
5	76	65	69	83	78	80	77	69	59

Pkt. Pracy	tot	Częstotliwości pasm oktaowych [Hz]							
		63	125	250	500	1000	2000	4000	8000
L_{WA} wlot [dB(A)]									
2	84	53	70	78	80	74	74	71	63
3	82	51	63	74	79	72	72	70	63
4	86	53	67	75	84	76	74	73	65
5	89	53	69	79	87	79	77	76	70
L_{WA} wylot [dB(A)]									
2	86	59	71	82	79	76	78	72	64
3	85	57	65	80	80	76	77	72	64
4	89	54	66	82	85	80	81	75	67
5	88	57	67	79	82	80	82	78	72
L_{WA} od obudowy [dB(A)]									
2	74	55	68	69	62	66	68	62	56
3	72	51	62	66	62	65	67	61	55
4	74	55	66	67	65	66	67	61	56
5	75	58	69	69	67	66	68	62	55

Pkt. Pracy	tot	Częstotliwości pasm oktaowych [Hz]							
		63	125	250	500	1000	2000	4000	8000
L_{WA} wlot [dB(A)]									
2	82	51	72	74	77	76	72	69	62
3	81	40	56	73	75	77	72	70	63
4	85	46	63	78	80	79	75	72	65
5	86	49	66	78	83	80	78	75	69
L_{WA} wylot [dB(A)]									
2	86	59	75	81	78	78	78	73	66
3	85	48	62	81	75	78	77	73	67
4	88	49	64	84	79	81	81	76	69
5	90	52	66	86	81	83	83	79	75
L_{WA} od obudowy [dB(A)]									
2	75	56	67	65	60	73	64	58	51
3	75	53	57	64	58	74	64	57	50
4	77	52	62	68	61	76	64	57	48
5	75	52	65	70	64	72	65	58	49

charakterystyki pracy

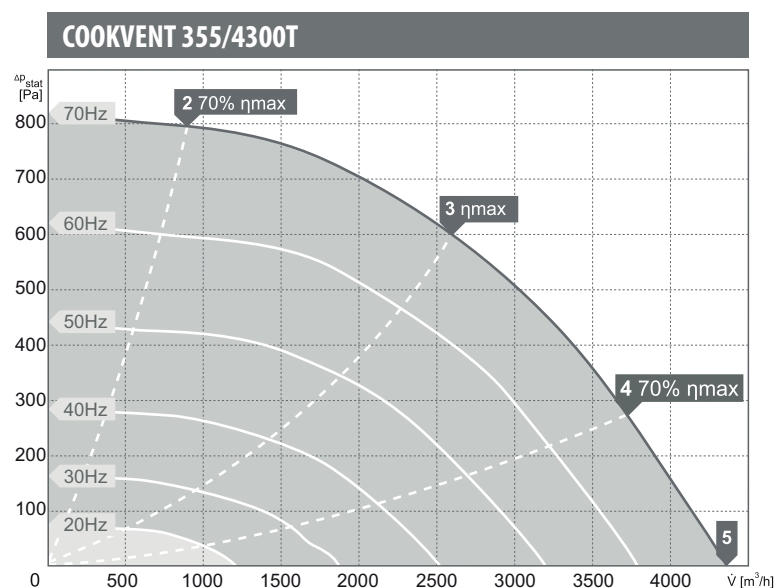
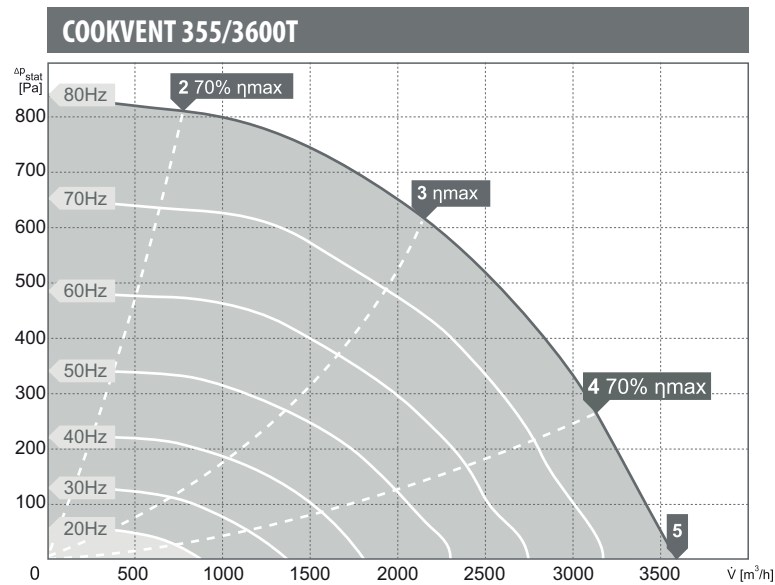
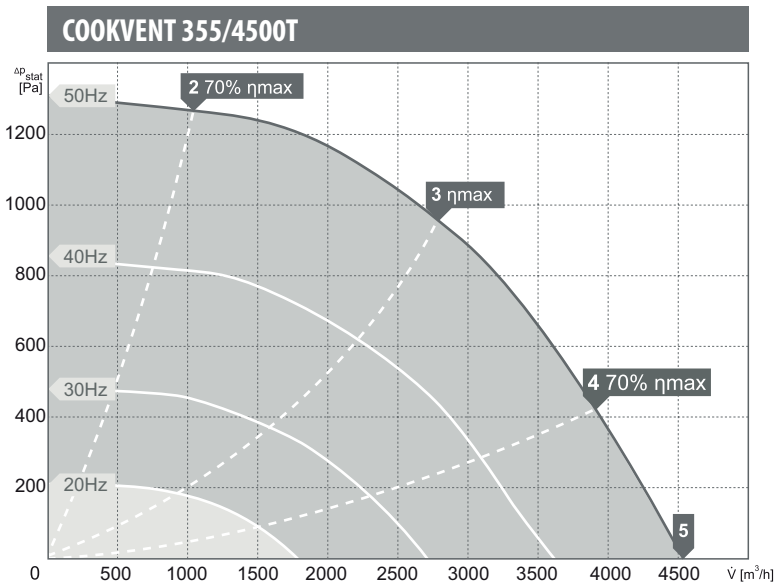

wartości mocy akustycznej L_{WA} [dB(A)]
dla poszczególnych częstotliwości pasm oktaowych [Hz]

Pkt. Pracy	tot	Częstotliwości pasm oktaowych [Hz]							
		63	125	250	500	1000	2000	4000	8000
L_{WA} wlot [dB(A)]									
2	86	57	71	83	80	76	75	74	66
3	87	48	61	84	79	76	76	74	67
4	91	54	66	89	84	80	79	77	70
5	93	57	68	90	87	82	81	79	73
L_{WA} wylot [dB(A)]									
2	88	59	73	84	78	80	80	75	68
3	87	51	63	82	78	81	80	76	69
4	90	52	66	82	81	85	84	79	72
5	92	54	67	84	83	87	85	81	76
L_{WA} od obudowy [dB(A)]									
2	75	57	67	71	62	65	66	63	54
3	72	50	58	66	62	65	66	63	54
4	75	60	64	70	65	66	67	64	56
5	75	60	66	71	66	67	68	65	57

Pkt. Pracy	tot	Częstotliwości pasm oktaowych [Hz]							
		63	125	250	500	1000	2000	4000	8000
L_{WA} wlot [dB(A)]									
2	79	51	66	74	73	70	70	66	58
3	79	38	57	73	73	71	71	67	60
4	83	43	63	78	78	74	73	70	62
5	85	46	67	81	80	77	76	74	66
L_{WA} wylot [dB(A)]									
2	80	55	69	75	72	74	73	68	59
3	80	44	56	75	71	75	74	68	61
4	84	44	59	77	75	79	77	72	63
5	89	51	64	83	80	83	82	78	72
L_{WA} od obudowy [dB(A)]									
2	70	53	61	66	56	59	63	55	49
3	71	42	54	66	56	60	69	55	48
4	72	47	59	69	60	61	65	55	47
5	72	50	62	70	62	62	64	57	49

Pkt. Pracy	tot	Częstotliwości pasm oktaowych [Hz]							
		63	125	250	500	1000	2000	4000	8000
L_{WA} wlot [dB(A)]									
2	81	53	68	72	74	74	74	72	67
3	81	45	59	72	75	75	75	73	70
4	84	46	65	76	79	78	77	75	71
5	86	48	68	79	81	80	78	77	72
L_{WA} wylot [dB(A)]									
2	82	54	68	74	72	76	75	73	66
3	82	46	58	72	72	76	76	73	68
4	84	48	64	76	76	80	78	75	69
5	86	50	66	79	78	82	80	77	70
L_{WA} od obudowy [dB(A)]									
2	69	51	63	64	57	58	60	55	49
3	68	45	56	65	57	59	62	56	52
4	71	48	62	68	60	61	62	57	52
5	73	50	65	70	62	62	62	58	52

charakterystyki pracy

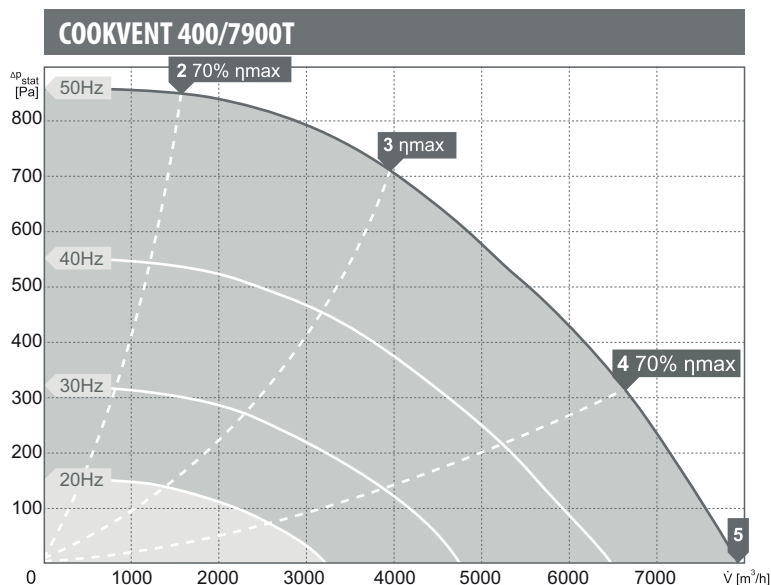
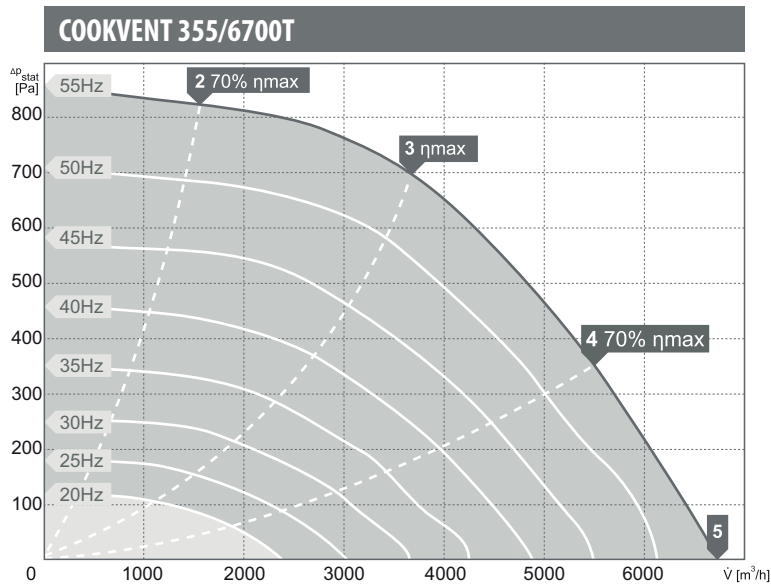
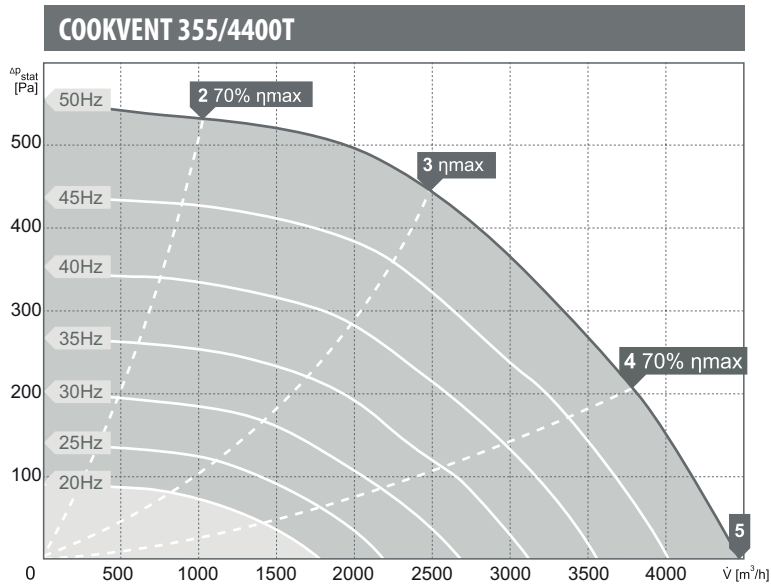

wartości mocy akustycznej L_{WA} [dB(A)]
dla poszczególnych częstotliwości pasm oktaowych [Hz]

Pkt. Pracy	tot	Częstotliwości pasm oktaowych [Hz]							
		63	125	250	500	1000	2000	4000	8000
L_{WA} wlot [dB(A)]									
2	73	48	65	66	68	65	65	62	54
3	74	42	66	68	67	66	66	63	55
4	78	46	71	72	72	69	69	66	59
5	80	50	71	74	74	71	71	69	62
L_{WA} wylot [dB(A)]									
2	74	51	65	66	65	70	67	62	57
3	74	45	64	65	65	70	67	63	56
4	77	48	65	68	68	72	70	66	58
5	79	52	68	71	71	74	72	70	60
L_{WA} od obudowy [dB(A)]									
2	65	47	60	60	51	54	51	45	45
3	66	46	62	63	53	55	52	46	42
4	70	50	65	68	55	55	53	48	43
5	72	52	67	70	57	56	54	51	52

Pkt. Pracy	tot	Częstotliwości pasm oktaowych [Hz]							
		63	125	250	500	1000	2000	4000	8000
L_{WA} wlot [dB(A)]									
2	82	54	70	76	75	75	75	72	63
3	82	50	67	77	76	74	73	71	62
4	85	48	69	80	78	77	76	74	65
5	86	53	71	81	81	79	78	76	68
L_{WA} wylot [dB(A)]									
2	83	61	70	76	74	77	76	73	64
3	82	58	67	78	73	76	75	71	64
4	86	58	69	81	77	79	78	75	67
5	87	61	71	82	79	81	80	77	68
L_{WA} od obudowy [dB(A)]									
2	73	56	66	71	60	59	58	54	46
3	74	51	64	73	61	60	57	52	46
4	77	54	66	76	62	62	60	56	49
5	80	56	70	79	64	62	62	58	50

Pkt. Pracy	tot	Częstotliwości pasm oktaowych [Hz]							
		63	125	250	500	1000	2000	4000	8000
L_{WA} wlot [dB(A)]									
2	82	58	75	74	75	76	74	69	61
3	83	54	74	75	75	77	77	73	64
4	85	58	77	77	77	78	78	73	65
5	86	62	79	79	78	79	79	75	66
L_{WA} wylot [dB(A)]									
2	84	60	71	72	76	80	76	72	62
3	83	54	70	70	74	80	77	73	63
4	84	58	73	74	75	80	77	73	63
5	86	63	74	77	78	81	79	75	65
L_{WA} od obudowy [dB(A)]									
2	72	54	68	67	59	60	59	54	46
3	72	51	68	66	60	63	60	56	47
4	75	55	72	70	62	64	61	56	47
5	77	61	75	72	63	63	62	58	48

charakterystyki pracy

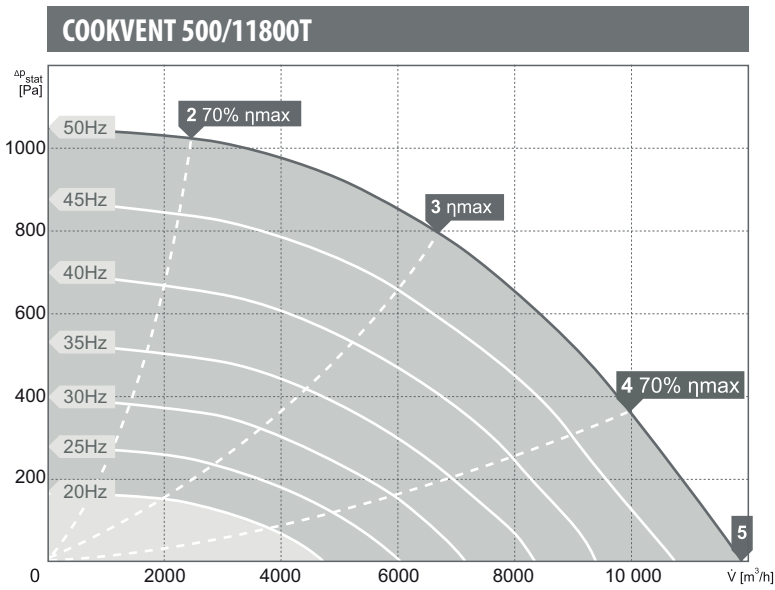

wartości mocy akustycznej L_{WA} [dB(A)]
dla poszczególnych częstotliwości pasm oktaowych [Hz]

Pkt. Pracy	tot	Częstotliwości pasm oktaowych [Hz]							
		63	125	250	500	1000	2000	4000	8000
L_{WA} wlot [dB(A)]									
2	85	62	75	76	78	80	79	74	67
3	87	54	77	76	78	82	80	75	69
4	89	58	80	80	81	82	81	76	69
5	90	60	82	82	83	84	83	79	71
L_{WA} wylot [dB(A)]									
2	86	66	76	75	79	82	79	74	66
3	86	56	75	72	78	82	80	75	68
4	89	58	79	77	82	84	81	77	69
5	91	60	82	80	84	85	83	80	70
L_{WA} od obudowy [dB(A)]									
2	75	60	72	66	65	65	63	59	53
3	76	52	73	66	65	66	63	59	54
4	78	56	76	71	68	67	64	60	53
5	80	58	77	73	69	68	66	62	54